

Technical sheet :

# **MT 1440 EASY ST5**

---



 **MANITOU**  
HANDLING YOUR WORLD

Capacities		Metric	Imperial
Max. capacity		4000 kg	8818 lb
Max. lifting height		13.53 m	44 ft 5 in
Max. outreach		9.46 m	31 ft
Breakout force with bucket		7400 daN	7400 daN
Weight and dimensions			
Overall length to carriage	l11	6.15 m	20 ft 2 in
Length to face of forks	l2	6.13 m	20 ft 1 in
Overall width	b1	2.36 m	7 ft 9 in
Overall height	h17	2.45 m	8 ft
Wheelbase	y	3.07 m	10 ft 1 in
Ground clearance	m4	0.37 m	1 ft 3 in
Overall cab width	b4	0.89 m	2 ft 11 in
Tilt-up angle	a4	12 °	12 °
Tilt-down angle	a5	114 °	114 °
External turning radius (over tyres)	Wa1	3.94 m	12 ft 11 in
Unladen weight (with forks)		10855 kg	23931 lb
Overall weight		10900 kg	24030 lb
Tyres type		Pneumatic	Pneumatic
Standard tyres		Alliance 400/80 - 24 - 162A8	Alliance 400/80 - 24 - 162A8
Forks length / width / section	l / e / s	1200 mm x 125 mm / 50 mm	47 in x 5 in / 2 in
Performances			
Lifting		16 s	16 s
Lowering		12.40 s	12.40 s
Extension		17.30 s	17.30 s
Retraction		13 s	13 s
Crowd		4 s	4 s
Dump		4 s	4 s
Engine			
Engine brand		Deutz	Deutz
Engine norm		Stage V / Tier 4 final	Stage V / Tier 4 final
Engine model		TD 3.6 L	TD 3.6 L
Number of cylinders / Capacity of cylinders		4 - 3621 cm <sup>3</sup>	4 - 221 in <sup>3</sup>
I.C. Engine power rating - Power (kW)		75 Hp / 55.40 kW	75 Hp / 55 kW
Max. torque / Engine rotation		340 Nm @ 1600 rpm	251 ft/lbs @ 1600 rpm
Drawbar pull (Laden)		8320 daN	8320 daN
Transmission			
Transmission type		Torque converter	Torque converter
Number of gears (forward / reverse)		4 / 4	4 / 4
Max. travel speed		24.90 km/h	15 mi/h
Parking brake		Automatic parking brake	Automatic parking brake
Service brake		Oil-immersed multi-discs braking on front & rear axles	Oil-immersed multi-discs braking on front & rear axles
Hydraulics			
Hydraulic pump type		Gear pump	Gear pump
Hydraulic flow / Pressure		160 l/min-270 bar	42 US gpm-3916 PSI
Tank capacities			
Engine oil		7.50 l	2 US gal
Hydraulic oil		135 l	36 US gal
Fuel tank		140 l	37 US gal
Noise and vibration			
Noise at driving position (LpA)		79 dB	79 dB
Noise to environment (LWA)		102 dB	102 dB
Vibration on hands/arms		< 2.50 m/s <sup>2</sup>	< 2.50 m/s <sup>2</sup>
Miscellaneous			
Steering wheels (front / rear)		2 / 2	2 / 2
Drive wheels (front / rear)		2 / 2	2 / 2
Safety / Safety cab homologation		Standard EN 15000 / Cabin ROPS - FOPS Level 2	Standard EN 15000 / Cabin ROPS - FOPS Level 2
Controls		JSM	JSM

### MT 1440 easy ST5 - Dimensional drawing

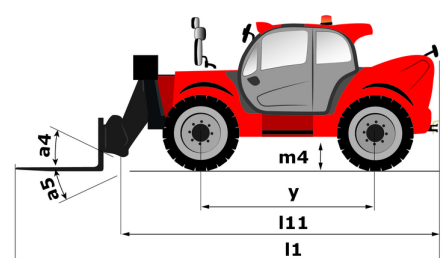
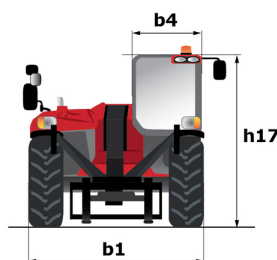
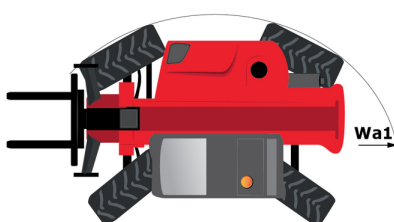

### MT 1440 easy ST5 - Load chart

Machine on tyres with forks - with levelling device Metric

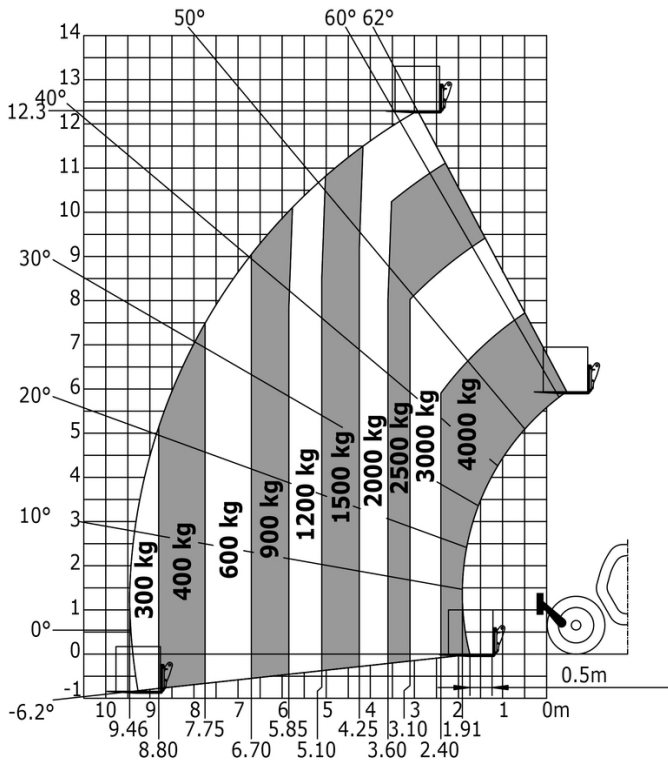

Machine on tyres with forks Imperial

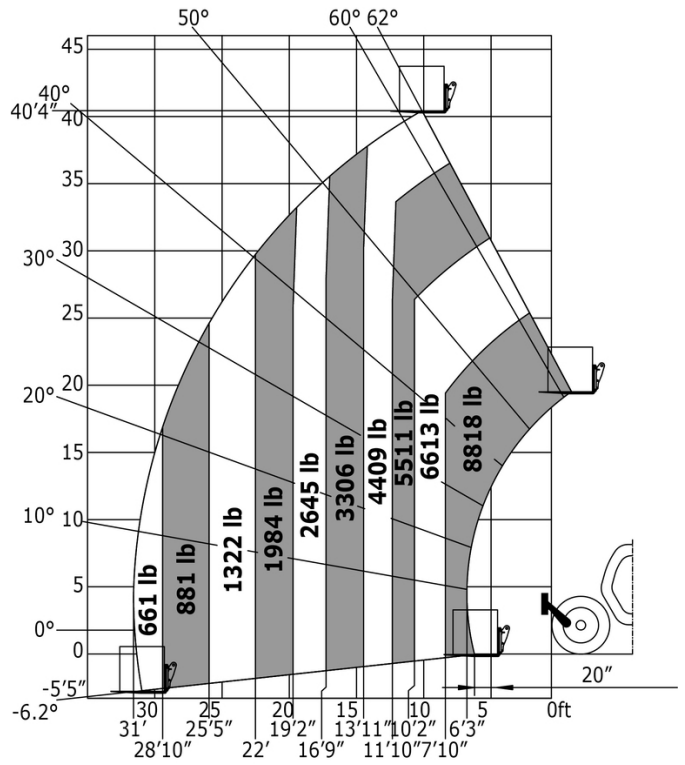

Machine on lowered stabilisers with forks Metric

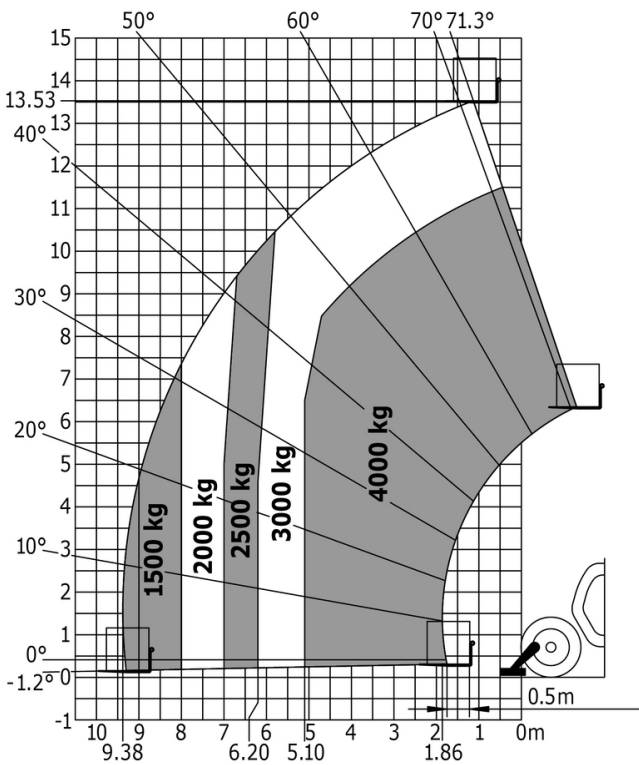

Machine on lowered stabilisers with forks Imperial

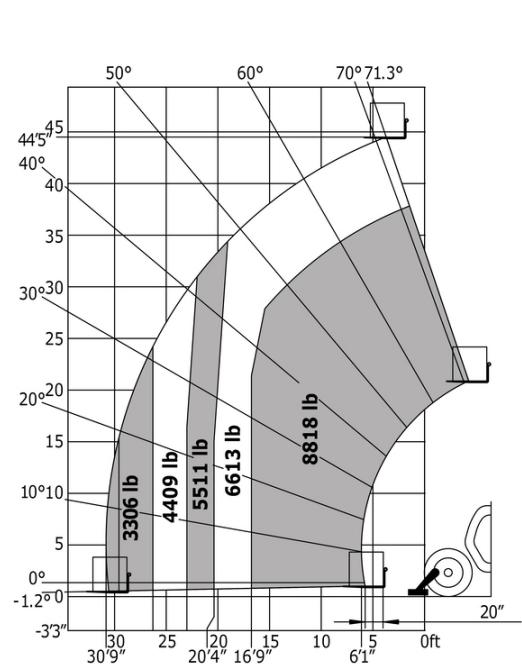



**Head Office**

B.P. 249 - 430 rue de l'Aubinière

44150 Ancenis Cedex - France

Tel: +33 (0)2 40 09 10 11 - Fax: +33 (0)2 40 09 10 97

[www.manitou.com](http://www.manitou.com)



This publication provides a description of the configuration versions and options for Manitou products, which may differ for equipment. The equipment presented in this brochure may be part of a series, as an option, or it may not be available, depending on the versions. Manitou reserves the right, at any time and without notice, to amend the specifications described and represented. The specifications provided do not bind the manufacturer. For more details, please contact your Manitou agent. This is not a contractually binding document. The presentation of the products is not contractually binding. List of specifications non-exhaustive. The logos as well as the visual identity of the company are owned by Manitou and cannot be used without authorisation. All rights reserved. The photos and diagrams contained in this brochure are only provided for consultation and information purposes.

MANITOU BF SA - Limited company with board of directors - Share capital: 39,668,399 euros - 857 802 508 RCS Nantes