



# ACCESSOIRES CATALOGUS

LANDBOUW

20 juni 2023

 **ATTACHMENTS**

# SET THE WORLD IN MOTION

De Manitou-groep werd meer dan 60 jaar geleden opgericht door de familie Braud en is nu over de hele wereld aanwezig. Als wereldleider op het gebied van het hanteren van ruw terrein ontwerpt, produceert, verdeelt en onderhoudt de groep uitrustingen voor de bouw, de landbouw en de industrie.

De productengamma's van het concern omvatten: vaste, roterende en zware verreikers voor ruw terrein, knikladers, ruwterrein-, semi-industriële en industriële masttrucks, schrankladers op wielen en rupsbanden, graaflaadmachines, hoogwerkers, on-board-trucks, magazijnuitrusting en aanbouwdelen.

Via zijn iconische merken, Manitou, Gehl, en zijn netwerk van 1.050 dealers wereldwijd, biedt de groep de beste oplossingen die de grootste waarde creëren voor zijn klanten.

De groep, met hoofdzetel in Frankrijk, realiseerde in 2021 een omzet van 1,9 miljard euro in 140 landen en stelt 4.500 mensen tewerk die resoluut focussen op klantentevredenheid.



2 merken

verdeeld door 1050 dealers in 140 landen



- 32 dochterondernemingen
- 10 productievestigingen
- 4500 werknemers wereldwijd
- 64% van de aandelen is in handen van de stichtende families
- 82% van de verkoop uit internationale markten
- 2021 omzet van 1,9 miljard euro



MANITOU is verheugd u deze nieuwe versie van zijn bijlagencatalogus voor te stellen. Het geeft u een volledig overzicht van het brede gamma goedgekeurde aanbouwdelen dat Manitou de markt voor zijn verreikers en vorkheftrucks.

Als fabrikant van verreikers en aanbouwdelen beschikt Manitou over de technische kennis, praktische ervaring en faciliteiten om elke combinatie van machine en aanbouwdeel te controleren en een perfecte efficiëntie te garanderen.

Manitou past een veeleisende interne procedure toe die leidt tot de goedkeuring van elk aanbouwdeel bij een machine. Deze unieke procedure garandeert veiligheid en een onovertroffen doeltreffendheid. Door een goedgekeurd Manitou-aanbouwdeel te kiezen en de beschreven compatibiliteit te respecteren, kunt u er zeker van zijn dat u het beste uit uw machine haalt, zonder in te boeten aan veiligheid en in overeenstemming met de Europese regelgeving.

Wij geloven dat u in deze catalogus alles zult vinden wat u nodig hebt. Hebt u iets nodig dat we nog niet aan ons aanbod hebben toegevoegd? Neem contact op met uw dichtstbijzijnde Manitou-dealer en onze afdeling voor speciale oplossingen kan u een oplossing op maat bieden voor uw behoeften.

---

Alle in dit document vermelde bevestigingscapaciteiten zijn nominale capaciteiten:

- De laadbakinhoud wordt berekend volgens ISO 7546: deze komt overeen met de volgens de norm berekende "koepelinhoud" in m<sup>3</sup>.
- De opgegeven grijperbakcapaciteiten zijn de totale capaciteit, gesloten grijper (in m<sup>3</sup>).
- De betonmixerbak, de rotorbak, de kiepbak en de kiepbak hebben een capaciteit in L en zijn berekend om een goede efficiëntie van alle functies te garanderen (watercapaciteit).
- De veegcapaciteiten zijn maximale vuilcapaciteiten.
- De capaciteit van de emmers wordt aangegeven in kg, inclusief 2 of 3 personen (afhankelijk van het type emmer).
- Alle andere capaciteiten zijn aangegeven in maximale veilige belasting.

## Compatibiliteit

Met het oog op de leesbaarheid hebben wij de lijst van machines in deze gids vereenvoudigd. Deze moet als volgt gelezen worden:

- Alle compatibiliteiten worden gegeven voor de machines die aanwezig zijn in het aanbod van Manitou op de dag van uitgifte van de gids.
- Voor oudere machines kunt u contact opnemen met uw Manitou dealer.

## Materiaaldichtheid gewicht

Materiaal	kg/m <sup>3</sup>	Materiaal	kg/m <sup>3</sup>
Appels	525	Mest (stalmest)	922
As	604	Nitraatmeststof	1250
Gerst	600	Haver	415
Bietenpulp (noten)	604	Uien	556
Bietenpulp (geperst)	906	Turf (droog)	400
Bierbostel	1110	Petroleumcokes	680
Baksteen toeslagmateriaal	1828	Aardappelen	699
Wortelen	636	Afval (stad)	318
Cement (natuurlijk)	874	Puin	1047
Cement (Portland)	1440	Zand (droog)	1550
Krijt	795	Zand (nat)	1890
Klei (fijn)	2080	Zaagsel	238
Klei (nat)	1680	Kuilvoer (kuilvoer)	747
Steenkool (antraciet)	1046	Kuilvoer (groen)	349
Steenkool (bitumineus)	765	Drijfmest	1780
Cokes (los)	570	Sneeuw (vers)	200
Aarde (droog)	1150	Sneeuw (nat)	400
Meststof (gemengd)	1030	Natriumchloride (droog zout)	1300
Meel	445	Stro (hoge dichtheid baal)	254
Grind (droog)	1650	Suikerbieten	530
Hooi (baal met normale dichtheid)	190	Rapen	540
limoen (snel)	881	Tarwe	730
Kalksteen (gemalen)	1530		

# SAMENVATTING

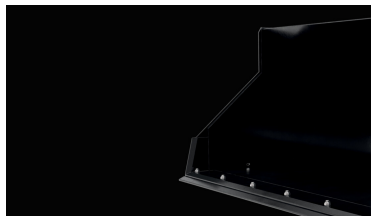

**BAKKEN**  
Bladzijde 9

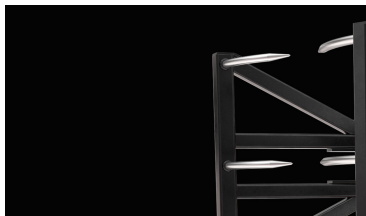

**KLEMMEN**  
Bladzijde 62



**VORKDRAGERS**  
Bladzijde 90



**VORKEN EN GRIJPERS**  
Bladzijde 133



**GIEKEN**  
Bladzijde 155



**VEEGMACHINES**  
Bladzijde 165

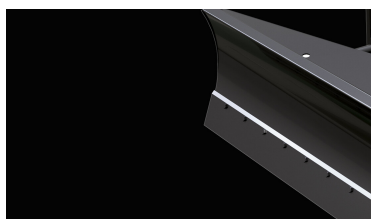

**LEVELLING SOLUTIONS**  
Bladzijde 181















**DIVERSE VOORZETSTUKKEN**  
Bladzijde 188

# INDEX

## BAKKEN

-  10 Allroundbak (compacte machines)
-  13 Bietenbak
-  15 Groot volumebak (compacte machines)
-  19 Groot volumebak (MRT) **NEW**
-  21 Groot volumebka met slijtmes (compacte machines)
-  23 Hoogkipbak (compacte machines)
-  25 Kuilhappers
-  27 Light Material Bucket **NEW**
-  29 Pelicaanbak
-  32 Pelicaanbak (met gelaste tanden)
-  35 Pelicaanbak met groot volume
-  37 Pelikaanbak (compacte machines)
-  39 Schepbak
-  43 Schepbak - Essentieel **NEW**
-  47 Standaard graafbak (compacte machines)
-  52 Uitkuilbak
-  54 Volumebak
-  56 Volumebak
-  59 Waste bak

## KLEMMEN

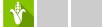
-  63 Balenklem
-  65 Balenklem intensief
-  67 Balenklem voor intensief gebruik
-  69 Balenklem voor rechthoekige balen
-  71 Gewikkelde balenklem (compacte machines)
-  73 Klassieke balenklem
-  75 Multifunctionele balenklem
-  77 potklem
-  79 Pottenklem (compacte machines)
-  81 Ronde balenklem (compacte machines)
-  83 Super compacte balenklem
-  85 Vierkante balenklem
-  87 Vierkante balenklem (compacte machines)



## VORKDRAGERS

-  91 Palletvorken compleet (compacte machines)
-  94 Rijtuig Drijvende Laadsteun En Vorken (MHT) **NEW**
-  97 Rijtuig Drijvende Laadsteun En Vorken (MRT) **NEW**
-  99 Rijtuig Drijvende Laadsteun En Vorken (MT - MLT) **NEW**
-  103 Vast vorkenbord
-  108 Vast vorkenbord (MRT - MHT) **NEW**
-  111 Vast vorkenbord met sideshift (MLT - MT)
-  114 Vast vorkenbord met sideshift (MRT - MHT) **NEW**
-  116 Verstelbare vorkschort met load backplash (MLT - MT)
-  119 Vlottend vorkenbord (MLT - MT)
-  122 Vlottend vorkenbord met hydraulische schuinstelling
-  124 Vlottend vorkenbord met sideshift (MLT - MT) **NEW**
-  127 Vlottend vorkenbord met sideshift (MRT) **NEW**
-  129 Zijdelingse kantelbare vorkdeur - Load backplash (MLT - MT)







## VORKEN EN GRIJPERS

-  134 Balenvork
-  136 Balenvork (compacte machines)
-  138 Kuilhapper
-  140 Mestklauw met hoge capaciteit
-  142 Mestriek met klauw
-  145 Mestvork (compacte machines)
-  148 Mestvork met klem (compacte machines)
-  152 Vork Bale Katoen **NEW**

## GIEKEN







-  156 Big bag handler
-  160 Op frame gemonteerd haak

## VEEGMACHINES







-  166 2-in-1 borstelmaschine
-  169 borstelmaschine met opvangbak
-  171 Hoge druk reiniger
-  173 Orienteerbare borstel (compacte machines)
-  175 Rubberblad (compacte machines)
-  177 Veegbak (compacte machines)

# INDEX

## LEVELLING SOLUTIONS

-    182 Hydr. Dozer blad (compacte machines)
-    185 Manueel Dozer blad (compacte machines)

## DIVERSE VOORZETSTUKKEN

-    189 Mand materialen **NEW**
-    192 Pruning clipper (Compact machines) **NEW**





# BAKKEN

## Bereik

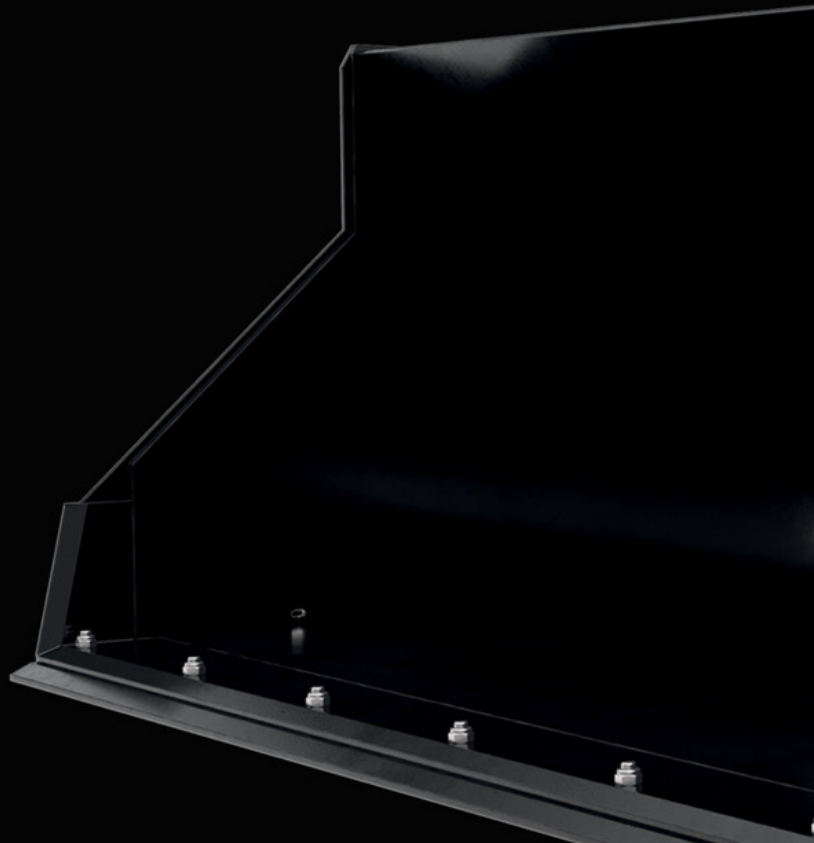

- 10 Allroundbak (compacte machines)
- 13 Bietenbak
- 15 Groot volumebak (compacte machines)
- 19 Groot volumebak (MRT) **NEW**
- 21 Groot volumebka met slijtmes (compacte machines)
- 23 Hoogkipbak (compacte machines)
- 25 Kuilhappers
- 27 Light Material Bucket **NEW**
- 29 Pelicaanbak
- 32 Pelicaanbak (met gelaste tanden)
- 35 Pelicaanbak met groot volume
- 37 Pelikaanbak (compacte machines)
- 39 Schepbak
- 43 Schepbak - Essentieel **NEW**
- 47 Standaard graafbak (compacte machines)
- 52 Uitkuilbak
- 54 Volumebak
- 56 Volumebak
- 59 Waste bak



## ALLROUNDBAK (COMPACTE MACHINES)



- Hogere capaciteit voor materialen met gemiddelde dichtheid ( $< 1,5$  t/m<sup>3</sup>).
- Robuust gebouwd voor intensieve laadtoepassingen.
- Slijtstuk en zijdelingse slijtstrippen in 400 HB.
- Veelzijdige bak, bijzonder interessant voor verhuurtoepassingen.

	BU 920 / 210	BU 1080 / 250	BU 1380 / 380	BU 1520 / 430	BU 1680 / 590	BU 1680 / 790	BU 1760 / 690	BU 1760 / 740
Capaciteit (lb)	694.46	826.73	1256.63	1421.98	1951.09	2612.48	2281.78	2447.13
Capaciteit van de koepel (US gal)	55.48	66.04	100.39	113.59	155.86	208.70	182.28	195.49
Gewicht (lb)	127.87	132.28	321.87	-	551.16	-	562.18	462.97
Totale hoogte (in)	1' 6"	1' 6"	1' 9"	1' 9"	1' 11"	2' 5"	2' 1"	2' 2"
Breedte (in)	3'	3' 7"	4' 6"	5'	5' 6"	5' 6"	5' 9"	5' 9"
Diepte (in)	2' 11"	2' 11"	2' 11"	2' 11"	3' 1"	3' 6"	3' 1"	3' 2"
Machine-apparatuur	×	×	×	×	×	×	×	×
Flexibele buis	Nee	Nee	Nee	-	Nee	-	Nee	Nee

Machine compatibiliteit								
All-Tach®	N726006	N726007	N736011	N736012	N747008	N51502033	N757009	N51502466
850 R	X	X	-	-	-	-	-	-
1050 R	-	-	X	-	-	-	-	-
1050 RT	-	-	X	-	-	-	-	-
1350 R NXT2	-	-	X	X	X	-	-	-
1350 RT	-	-	X	X	X	-	-	-
1640 E	X	X	-	-	-	-	-	-
1650 R	-	-	-	-	X	-	X	-
1650 RT	-	-	-	-	X	-	X	-
1850 RT	-	-	-	-	-	X	-	-
1900 R	-	-	-	-	X	-	-	X
2100V	-	-	-	-	X	-	-	-
2200 R	-	-	-	-	-	-	-	X
2300V	-	-	-	-	-	-	X	X
2700 V NXT:2	-	-	-	-	-	-	X	-
2750V	-	-	-	-	-	-	X	X
R105	-	-	X	-	-	-	-	-
R135	-	-	X	X	X	-	-	-
R165	-	-	-	-	X	-	X	-
R190	-	-	-	-	X	-	-	X
R220	-	-	-	-	-	-	-	X
RT105	-	-	X	-	-	-	-	-
RT135	-	-	X	X	X	-	-	-
RT165	-	-	-	-	X	-	X	-
RT185	-	-	-	-	-	X	-	-
V210 - NEW	-	-	-	-	X	-	-	-
V230 - NEW	-	-	-	-	-	-	X	X
V270	-	-	-	-	-	-	X	-
V275 - NEW	-	-	-	-	-	-	X	X

**VERPLICHTE UITRUSTING VAN MACHINES :** ×

	BU 1760 / 830	BU 1830 / 720	BU 1830 / 780	BU 1850 / 900	BU 1880 / 900	BU 2080 / 1010	BU 2140 / 1050 (a)	BU 2140 / 1050 (b)
Capaciteit (lb)	2744.76	2380.99	2579.41	2976.24	2976.24	3340	3472.28	3472.28
Capaciteit van de koepel (US gal)	219.26	190.20	206.05	237.75	237.75	266.81	277.38	277.38
Gewicht (lb)	-	573.20	496.04	-	793.66	815.71	833.35	833.35
Totale hoogte (in)	2' 5"	2' 1"	2' 2"	2' 5"	2' 5"	2' 5"	2' 5"	2' 5"
Breedte (in)	5' 9"	6'	6'	6' 1"	6' 2"	6' 10"	7'	7'
Diepte (in)	3' 6"	3' 1"	3' 2"	3' 6"	3' 6"	3' 6"	3' 6"	3' 6"
Machine-apparatuur	×	×	×	×	×	×	×	×
Flexibele buis	-	Nee	Nee	-	Nee	Nee	Nee	Nee

Machine compatibiliteit								
All-Tach®	N51502034	N757010	N51502467	N51502035	N51502074	N51502075	N700247	N51502036
1850 RT	X	-	-	X	-	-	-	-
2100VT	X	-	-	X	-	X	-	-
2150 RT	-	-	-	X	-	-	-	X
2200 R	-	-	X	-	-	-	-	-
2300VT	-	-	-	X	-	-	-	-
2600 R	-	-	X	-	X	-	-	-
2700 V NXT:2	-	X	-	-	-	-	-	-
2750V	-	-	-	-	X	X	-	-
2750VT	-	-	-	-	-	-	-	X
3300 V NXT:2	-	-	-	-	X	X	X	-
4200 V	-	-	-	-	-	X	X	-
R220	-	-	X	-	-	-	-	-
R260	-	-	X	-	X	-	-	-
RT185	X	-	-	X	-	-	-	-
RT215	-	-	-	X	-	-	-	X
V270	-	X	-	-	-	-	-	-
V275 - NEW	-	-	-	-	X	X	-	-
V330	-	-	-	-	X	X	X	-
VT210 - NEW	X	-	-	X	-	X	-	-
VT230 - NEW	-	-	-	X	-	-	-	-
VT275 - NEW	-	-	-	-	-	-	-	X

**VERPLICHTE UITRUSTING VAN MACHINES :** ×



# BIETENBAK

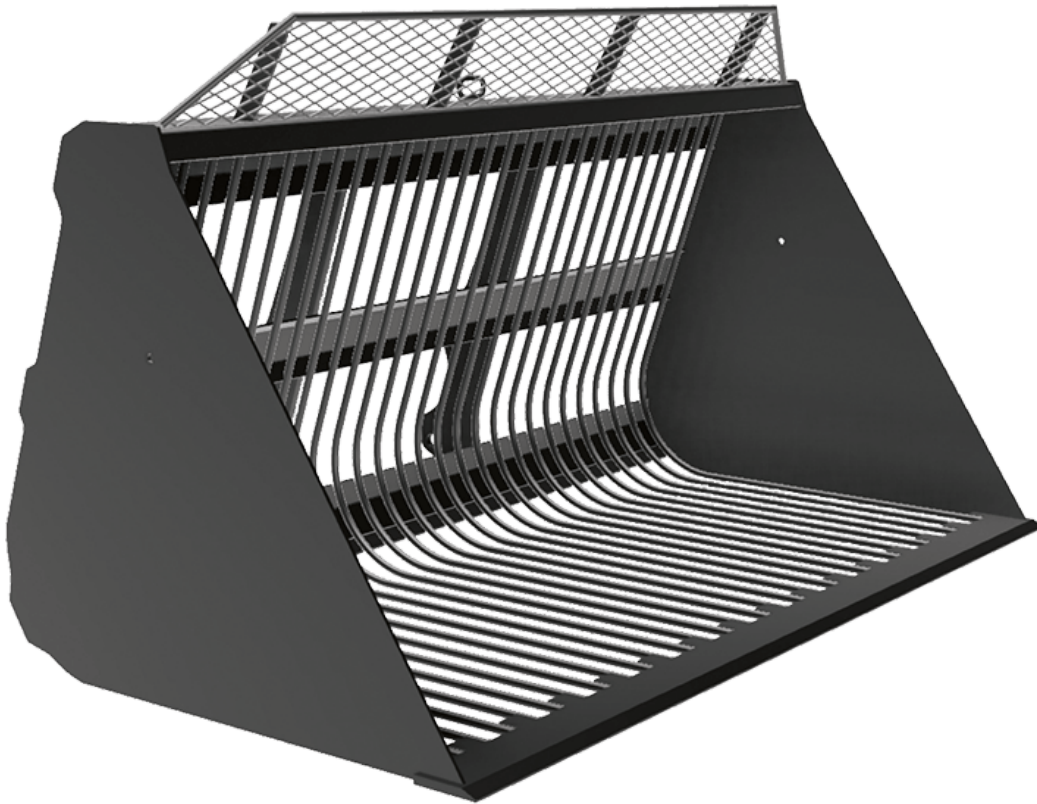

- Open bodem inde bak met staven  $\varnothing$  20 mm.
- Staafafstand van 60 mm, aangepast voor bieten.
- Gesloten zijwanden.
- Maximale dichtheid van de vervoerde producten : 700 kg/m<sup>3</sup>.

- Bak ontworpen om bieten en andere wortels te verhandelen.
- Structuur met open stroken.
- Frontwand met open stroken voor een uitstekende zichtbaarheid.
- Is niet bestemd om grondwerken uit te voeren of stenen te verplaatsen.

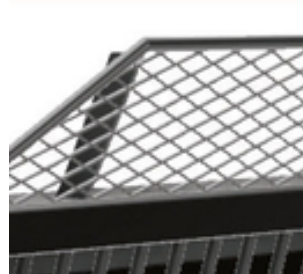

BSB 2450 / 2500	
Capaciteit (lb)	3064.43
Capaciteit van de koepel (US gal)	660.43
Gewicht (lb)	1146.40
Totale hoogte (in)	4' 6"
Totale lengte (in)	4' 6"
Breedte (in)	8'
Diepte (in)	4' 2"
Machine-apparatuur	×

Machine compatibiliteit	
Referentienummer	757953
MLT 630-115	X
MLT 630-115 V	X
MLT 630-115 V CP	X
MLT 635-130 PS+	X
MLT 635-140 V+	X
MLT 730-115 V	X
MLT 730-115 V CP	X
MLT 733-115	X
MLT 733-115 LSU	X
MLT 737-130 PS+	X
MLT 741-130 PS+	X
MLT 741-140 V+	X
MLT 841-145 PS+	X
MLT 940-140 V+	X
MLT 1041-145 PS+L	X
MLT-X 732	X
MLT-X 735 T LSU	X
MLT-X 735 T LSU (70 KW)	X
MLT-X 737-130 PS+	X
MLT-X 741-140 V+	X
MLT-X 841 - 145 PS+	X
MLT-X 1041-145 PS+L	X

VERPLICHTE UITRUSTING VAN MACHINES : ×



## GROOT VOLUMEBAK (COMPACTE MACHINES)



- Bestemd voor vrac materialen met een dichtheid <math>< 1\text{t/m}^3</math>.
- LSlijtmessen 400 HB voor een grotere slijtvastheid.
- Breed gamma bakken van verschillende capaciteiten.
- Grotere capaciteiten voor doeltreffende laadtoepassingen.

	BLM 920 / 240	BLM 1080 / 290	BLM 1220 / 330	BLM 1300 / 630 (c)	BLM 1380 / 430	BLM 1400 / 680 (b)	BLM 1400 / 680 (c)	BLM 1500 / 730 (c)
Capaciteit (lb)	529.11	639.34	727.53	1388.91	947.99	1499.14	1499.14	1609.37
Capaciteit van de koepel (US gal)	63.40	76.61	87.18	166.43	113.59	179.64	179.64	192.85
Gewicht (lb)	136.69	147.71	-	451.95	308.65	462.97	462.97	485.02
Totale hoogte (in)	1' 7"	1' 7"	1' 7"	2' 7"	2'	2' 7"	2' 7"	2' 7"
Breedte (in)	3'	3' 7"	4'	4' 3"	4' 6"	4' 7"	4' 7"	4' 11"
Diepte (in)	2' 8"	2' 8"	2' 8"	3' 2"	2' 11"	3' 3"	3' 2"	3' 1"
Machine-apparatuur	×	×	×	×	×	×	×	×
Flexibele buis	Nee	Nee	-	Nee	Nee	Nee	Nee	Nee

Machine compatibiliteit								
All-Tach®	N726009	N726010	N726011	N004092	N736013	N004089	N004093	N004094
4 point Carriage	-	-	-	N003092	-	52799520	N003093	N003094
Euro Carriage	-	-	-	N51502185	-	N51502161	N51502186	N51502187
850 R	X	X	-	-	-	-	-	-
1050 R	-	-	X	-	X	-	-	-
1050 RT	-	-	X	-	X	-	-	-
1350 R NXT2	-	-	X	-	X	-	-	-
1350 RT	-	-	X	-	X	-	-	-
1640 E	X	X	-	-	-	-	-	-
AL230	-	-	-	X	-	-	-	-
AL420	-	-	-	-	-	X	-	-
AL430	-	-	-	-	-	X	-	-
AL550	-	-	-	X	-	-	X	X
MLA 2-25 H	-	-	-	X	-	-	-	-
MLA 4-50 H	-	-	-	-	-	X	-	-
MLA 4-50 H-C	-	-	-	-	-	X	-	-
MLA 5-50 H	-	-	-	-	-	-	X	-
MLA 5-60 H-Z	-	-	-	X	-	-	X	X
R105	-	-	X	-	X	-	-	-
R135	-	-	X	-	X	-	-	-
RT105	-	-	X	-	X	-	-	-
RT135	-	-	X	-	X	-	-	-

VERPLICHTE UITRUSTING VAN MACHINES : ✕



	BLM 1520 / 480	BLM 1650 / 1100	BLM 1680 / 530	BLM 1680 / 670	BLM 1760 / 790	BLM 1760 / 820	BLM 1800 / 1200	BLM 1850 / 830
Capaciteit (lb)	1058.22	1785.74	1168.45	1477.10	1807.79	1741.65	1785.74	1895.98
Capaciteit van de koepel (US gal)	126.80	213.98	140.01	177	216.62	208.70	213.98	227.19
Gewicht (lb)	-	2425.08	352.74	533.52	606.27	582.02	2645.55	639.34
Totale hoogte (in)	2'	2' 8"	2'	2'	2' 4"	2' 4"	2' 8"	2' 4"
Breedte (in)	5'	5' 5"	5' 6"	5' 6"	5' 9"	5' 9"	5' 11"	6' 1"
Diepte (in)	2' 11"	4'	2' 11"	3' 4"	3' 4"	3' 4"	4'	3' 4"
Machine-apparatuur	×	×	×	×	×	×	×	×
Flexibele buis	-	Nee	Nee	Nee	Nee	Nee	Nee	Nee

Machine compatibiliteit								
All-Tach®	N736014	N51502537	N736015	N747011	N757013	N51502468	N51502536	N757014
4 point Carriage	-	N51502603	-	-	-	-	N51502605	-
Euro Carriage	-	N51502562	-	-	-	-	N51502564	-
1350 R NXT2	X	-	X	-	-	-	-	-
1350 RT	X	-	X	-	-	-	-	-
1650 R	-	-	-	X	-	-	-	-
1650 RT	-	-	-	X	-	-	-	-
1900 R	-	-	-	X	-	-	-	-
2100V	-	-	-	X	-	X	-	X
2100VT	-	-	-	X	-	-	-	-
2200 R	-	-	-	-	-	X	-	-
2300V	-	-	-	-	X	X	-	X
2700 V NXT:2	-	-	-	-	X	-	-	X
2750V	-	-	-	-	X	-	-	-
AL650	-	X	-	-	-	-	X	-
AL750	-	X	-	-	-	-	X	-
MLA 6-65 H-Z	-	X	-	-	-	-	X	-
MLA 7-75 H-Z	-	X	-	-	-	-	X	-
R135	X	-	X	-	-	-	-	-
R165	-	-	-	X	-	-	-	-
R190	-	-	-	X	-	-	-	-
R220	-	-	-	-	-	X	-	-
RT135	X	-	X	-	-	-	-	-
RT165	-	-	-	X	-	-	-	-
V210 - NEW	-	-	-	X	-	X	-	X
V230 - NEW	-	-	-	-	X	X	-	X
V270	-	-	-	-	X	-	-	X
V275 - NEW	-	-	-	-	X	-	-	-
VT210 - NEW	-	-	-	X	-	-	-	-

**VERPLICHTE UITRUSTING VAN MACHINES :** ×

	BLM 1850 / 860	BLM 1850 / 1100	BLM 1950 / 1300	BLM 2080 / 1250	BLM 2140 / 1290	BLM 2150 / 1420	BLM 2350 / 1370 (a)	BLM 2350 / 1370 (b)
Capaciteit (lb)	1829.84	2425.08	2866.01	2755.78	2843.96	3130.56	3020.33	3020.33
Capaciteit van de koepel (US gal)	219.26	290.59	343.42	330.22	340.78	375.12	361.92	361.92
Gewicht (lb)	606.27	771.62	780.44	815.71	839.96	837.76	892.87	892.87
Totale hoogte (in)	2' 4"	2' 9"	2' 8"	2' 9"	2' 9"	2' 8"	2' 9"	2' 9"
Breedte (in)	6' 1"	6' 1"	6' 5"	6' 10"	7'	7' 1"	7' 9"	7' 9"
Diepte (in)	3' 4"	3' 7"	4'	3' 7"	3' 7"	4'	3' 7"	3' 7"
Machine-apparatuur	×	×	×	×	×	×	×	×
Flexibele buis	Nee	Nee	Nee	Nee	Nee	Nee	Nee	Nee

Machine compatibiliteit								
All-Tach®	N51502469	N51502037	N51502535	N51502076	N700248	N51502534	N700249	N51502038
4 point Carriage	-	-	N51502607	-	-	N51502609	-	-
Euro Carriage	-	-	N51502566	-	-	N51502568	-	-
1850 RT	-	X	-	-	-	-	-	-
2100VT	-	X	-	-	-	-	-	-
2150 RT	-	X	-	-	-	-	-	X
2200 R	X	-	-	-	-	-	-	-
2300V	X	-	-	-	-	-	-	-
2300VT	-	X	-	-	-	-	-	-
2600 R	X	-	-	X	-	-	-	-
2750V	X	-	-	X	-	-	-	-
2750VT	-	-	-	-	-	-	-	X
3300 V NXT:2	-	-	-	X	X	-	-	-
4200 V	-	-	-	X	X	-	X	-
AL650	-	-	X	-	-	-	-	-
AL750	-	-	X	-	-	X	-	-
MLA 6-65 H-Z	-	-	X	-	-	-	-	-
MLA 7-75 H-Z	-	-	X	-	-	X	-	-
R220	X	-	-	-	-	-	-	-
R260	X	-	-	X	-	-	-	-
RT185	-	X	-	-	-	-	-	-
RT215	-	X	-	-	-	-	-	X
V230 - NEW	X	-	-	-	-	-	-	-
V275 - NEW	X	-	-	X	-	-	-	-
V330	-	-	-	X	X	-	-	-
VT210 - NEW	-	X	-	-	-	-	-	-
VT230 - NEW	-	X	-	-	-	-	-	-
VT275 - NEW	-	-	-	-	-	-	-	X

VERPLICHTE UITRUSTING VAN MACHINES : ✕



NEW

## GROOT VOLUMEBAK (MRT)



- Bucket dedicated to the handling of light materials (< 1000kg/m<sup>3</sup>).
- Reinforced structure (base, blade and sides).
- Usually placed in from on a window/ an opening on a deconstructed building to load rubbles.
- Especially usefull for deconstruction applications: the wide opening of this bucket prevents rubbles & misc. materials from falling to the ground.
- Designed to suit to MRT's specific boom head position.
- Note: rotating telehandlers are not designed for intensive loading applications.

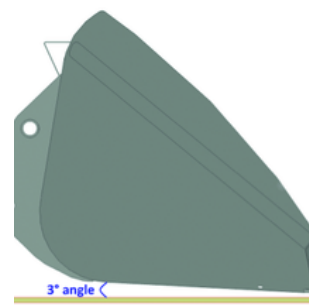
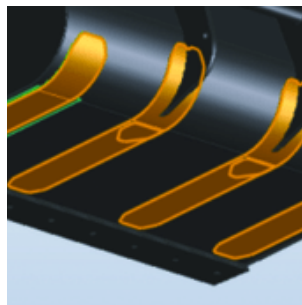
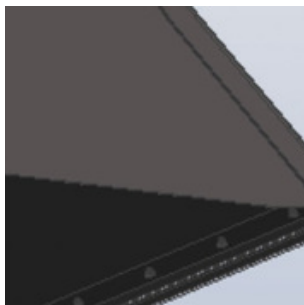

CBA 1500 / 2450	
Capaciteit (lb)	3370.87
Capaciteit van de koepel (US gal)	403.92
Slagcapaciteit (US gal)	290.85
Gewicht (lb)	1166.25
Totale hoogte (in)	3' 3"
Totale lengte (in)	3' 10"
Breedte (in)	8'
Machine-apparatuur	×
Flexibele buis	Nee

Machine compatibiliteit	
Referentienummer E-RECO	921279
MRT 1645 75	X
MRT 1645 115	X
MRT 1845 75	X
MRT 1845 115	X
MRT 2145 115	X
MRT 2260	X
MRT 2260 e	X
MRT 2545 115	X
MRT 2570	X
MRT 2660	X
MRT 2660 e	X
MRT 3060	X
MRT 3570	X
MRT 3570 ES	X
MRT-X 1645	X
MRT-X 1845	X
MRT-X 2145	X
MRT-X 2260	X
MRT-X 2545	X
MRT-X 2570	X
MRT-X 2660	X
MRT-X 3060	X
MRT-X 3570	X
MRT-X 3570 ES	X

**VERPLICHTE UITRUSTING VAN MACHINES : ×**



## GROOT VOLUME BKA MET SLIJTMES (COMPACTE MACHINES)



- Bestemd voor vrac materialen met een dichtheid  $< 1 \text{ t/m}^3$ .
- Slijtgedeelte in 400 HB voor een langere levensduur.
- Breed gamma bakken van verschillende capaciteiten.
- Grotere capaciteiten voor doeltreffende laadtoepassingen.

	BLM WP 1650 / 1100	BLM WP 1800 / 1200	BLM WP 1950 / 1300	BLM WP 2150 / 1420
Capaciteit (lb)	2425.08	2645.55	2866.01	3130.56
Capaciteit van de koepel (US gal)	290.59	317.01	343.42	375.12
Gewicht (lb)	753.98	804.69	853.19	919.33
Totale hoogte (in)	2' 8"	2' 8"	2' 8"	2' 8"
Breedte (in)	5' 5"	5' 11"	6' 5"	7' 1"
Diepte (in)	4' 2"	4' 2"	4' 2"	4' 2"
Machine-apparatuur	×	×	×	×
Flexibele buis	Nee	Nee	Nee	Nee

## Machine compatibiliteit

All-Tach®	N51502533	N51502532	N51502531	N51502530
4 point Carriage	N51502604	N51502606	N51502608	N51502610
Euro Carriage	N51502563	N51502565	N51502567	N51502569
AL650	X	X	X	-
AL750	X	X	X	X
MLA 6-65 H-Z	X	X	X	-
MLA 7-75 H-Z	X	X	X	X

VERPLICHTE UITRUSTING VAN MACHINES : ×



## HOOGKIPBAK (COMPACTE MACHINES)

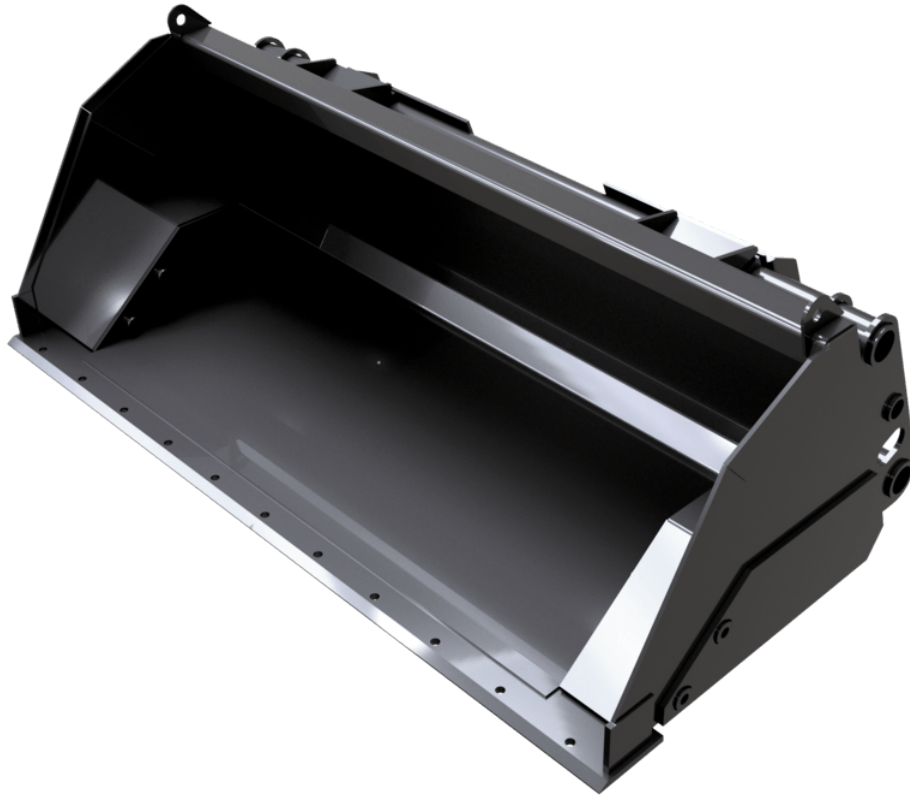

- Voor materialen met een dichtheid  $< 1,8 \text{ t/m}^3$ .
- Verhoogt de hefhoogte van de machine aanzienlijk (+ 800 mm of meer).
- Verbeterd de efficiëntie van laadtoepassingen van vrachtwagens/containers.

BHS 1525 / 550	
Capaciteit (lb)	2182.58
Capaciteit van de koepel (US gal)	145.29
Gewicht (lb)	749.57
Totale hoogte (in)	2' 1"
Breedte (in)	5'
Diepte (in)	3' 2"
Machine-apparatuur	
Flexibele buis	Nee

Machine compatibiliteit	
All-Tach®	N004050
AL650	X
AL750	X
MLA 6-65 H-Z	X
MLA 7-75 H-Z	X

**VERPLICHTE UITRUSTING VAN MACHINES :** 





## KUILHAPPERS

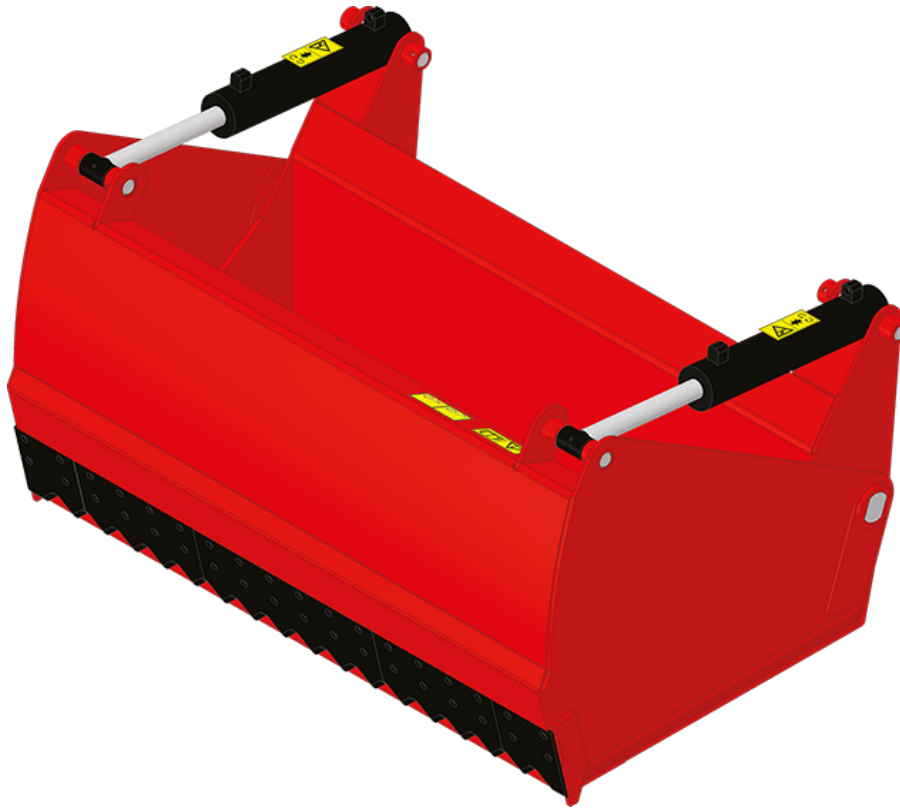

- Versterkte structuur, stijfheid en levensduur.
- Basis in hoog resistent staal.
- Tandens in hoog resistent staal voor een beter snijeffect.
- De zijdelingse structuren laten een goede penetratie in de hoop toe en een nauwkeurig snijeffect.
- Cilinders met grotere diameter om meer vermogen over te dragen.
- Slijtmes 500 HB.
- Snij- en verhandeloplossing voor ingekuilde voeders.
- Nauwkeurig en doeltreffend snijeffect van silage.
- Glad snijeffect voor de kuil, om opwarmingen te beperken.
- Krachtig werktuig om snel te kunnen snijden.
- Vastgeboute tanden voor een eenvoudig onderhoud.
- Gesloten bak aan de onderkant, ideaal om krachtvoerders of andere materialen te vervoeren.



	SHB 2200 / 1650	SHB 2400 / 1800
Capaciteit (lb)	3637.63	3968.32
Capaciteit van de koepel (US gal)	435.88	475.51
Gewicht (lb)	1966.52	2380.99
Totale hoogte (in)	3' 4"	3' 4"
Totale lengte (in)	4' 3"	4' 3"
Breedte (in)	7' 5"	8' 1"
Geopende grijphoogte (in)	4' 10"	4' 10"
Diepte (in)	2' 9"	2' 9"
Machine-apparatuur		
Hardheid slijtplaat	500	500

Machine compatibiliteit		
Referentienummer	52000386	52000387
ALT950	X	-
MLA-T 533-145 V+ - ST5	X	-
MLT 635-130 PS+	X	-
MLT 635-140 V+	X	-
MLT 733-115	-	X
MLT 733-115 LSU	-	X
MLT 737-130 PS+	-	X
MLT 741-130 PS+	-	X
MLT 741-140 V+	-	X
MLT 841-145 PS+	-	X
MLT 850-145 V+	-	X
MLT 940-140 V+	-	X
MLT 1041-145 PS+L	-	X
MLT-X 732	X	-
MLT-X 735 T LSU	X	-
MLT-X 735 T LSU (70 KW)	X	-
MLT-X 737-130 PS+	-	X
MLT-X 741-140 V+	-	X
MLT-X 741 T LSU	X	X
MLT-X 841 - 145 PS+	-	X
MLT-X 850-145 V+	-	X
MLT-X 1041-145 PS+L	-	X

VERPLICHTE UITRUSTING VAN MACHINES :



NEW

## LIGHT MATERIAL BUCKET



- Suited for bulk materials with a density  $< 0.8\text{t/m}^3$ .
- 400HB cutting edge for more resistance.
- High capacity for efficient loading applications.

BLM 1500 / 770	
Capaciteit (lb)	1344.82
Capaciteit van de koepel (US gal)	201.56
Slagcapaciteit (US gal)	161.94
Gewicht (lb)	460.77
Totale hoogte (in)	2' 7"
Totale lengte (in)	4'
Breedte (in)	4' 11"
Machine-apparatuur	×

Machine compatibiliteit	
All-Tach®	52706270
4 point Carriage	52723640
Euro Carriage	52723641
GCT 3-14	X
GCT 3-14 +	X
ULM 412 H	X
ULM 412 H	X
ULM 415 H	X
ULM 415 H	X

**VERPLICHTE UITRUSTING VAN MACHINES : ×**







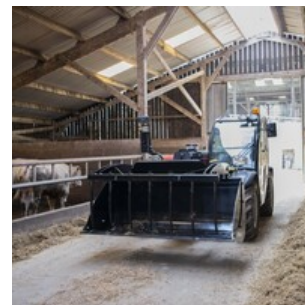

## PELICAANBAK



- Gesmeede tanden -FO.
- Verhandeling van materialen met een dichtheid  $\leq 1000 \text{ kg/m}^3$ .
- Demonteerbare zijwanden, anti-mors beveiliging en standaard geschroefd mes 500HB.
- Versterkte bouw (basis, mes en grijper).
- Behandelde hefcilinders, alle assen met een 'constructie' montage.
- Habituellement placé sur une fenêtre/une ouverture sur un bâtiment déconstruit pour charger les gravats.
- Particulièrement utile pour les applications de déconstruction : la large ouverture de ce godet empêche les gravats et les matériaux divers de tomber sur le sol.
- Conçu pour s'adapter à la position spécifique de la tête de flèche de MRT.
- Remarque : les chariots télescopiques rotatifs ne sont pas conçus pour des applications de chargement intensif.



	BG 1500 / 850 FO	BG 1850 / 1050 FO	BG 2100 / 1200 FO	BG 2300 / 1350 FO	BG 2450 / 1400 FO	BG 2450 / 1700 FO
Capaciteit (lb)	1873.93	2334.70	2645.55	2943.17	3143.79	3736.84
Capaciteit van de koepel (US gal)	224.55	279.76	317.01	352.67	376.71	447.77
Slagcapaciteit (US gal)	137.63	171.71	195.49	214.77	229.30	303.80
Gewicht (lb)	1234.59	1402.14	1587.33	1682.13	1770.31	1918.02
Totale lengte (in)	4' 1"	4' 2"	4' 1"	4' 1"	4' 1"	4' 6"
Breedte (in)	4' 11"	6' 1"	6' 11"	7' 7"	8'	8'
Gesloten grijphoogte (in)	3' 5"	3' 5"	3' 5"	3' 5"	3' 5"	3' 8"
Geopende grijphoogte (in)	5' 6"	5' 6"	5' 6"	5' 6"	5' 6"	6' 2"
Machine-apparatuur						
Tanden	6	7	8	9	10	11
Minimum spreiding vorken (in)	10"	10"	10"	10"	10"	9"
Maximum spreiding vorken (in)	10"	10"	10"	10"	10"	9"
Slijtplaat met bouten (LDR)	Standaard	Standaard	Standaard	Standaard	Standaard	Standaard
Hardheid slijtplaat	500	500	500	500	500	500

## Machine compatibiliteit

Referentienummer	52651958	52647327	52647329	52647331	52647333	52549810
Referentievorkenbord schranklader	52651957	-	-	-	-	-
ALT950	-	-	-	X	X	X
MLA-T 533-145 V+ - ST5	-	-	-	X	X	X
MLT 420-60 H	X	-	-	-	-	-
MLT 625-75 H	-	X	-	-	-	-
MLT 630-115	-	-	X	X	X	X
MLT 630-115 V	-	-	X	X	X	X
MLT 630-115 V CP	-	-	X	X	X	X
MLT 635-130 PS+	-	-	-	-	X	X
MLT 635-140 V+	-	-	-	-	X	X
MLT 730-115 V	-	-	X	X	X	X
MLT 730-115 V CP	-	-	X	X	X	X
MLT 733-115	-	-	-	-	X	X
MLT 733-115 LSU	-	-	-	-	X	X
MLT 737-130 PS+	-	-	-	-	X	X
MLT 741-130 PS+	-	-	-	-	X	X
MLT 741-140 V+	-	-	-	-	X	X
MLT 841-145 PS+	-	-	-	-	X	X
MLT 850-145 V+	-	-	-	-	-	X
MLT 940-140 V+	-	-	-	-	X	X
MLT 1041-145 PS+L	-	-	-	-	X	X
MLT-X 625-75 H	-	X	-	-	-	-
MLT-X 732	-	-	-	-	X	-
MLT-X 735 T LSU	-	-	-	-	X	X
MLT-X 737-130 PS+	-	-	-	-	X	X
MLT-X 741-140 V+	-	-	-	-	X	X
MLT-X 741 T LSU	-	-	-	-	X	X
MLT-X 841 - 145 PS+	-	-	-	-	X	X
MLT-X 850-145 V+	-	-	-	-	-	X

**BG 1500 / 850 FO** **BG 1850 / 1050 FO** **BG 2100 / 1200 FO** **BG 2300 / 1350 FO** **BG 2450 / 1400 FO** **BG 2450 / 1700 FO**

Machine compatibiliteit						
MLT-X 1041-145 PS+L	-	-	-	-	X	X

**VERPLICHTE UITRUSTING VAN MACHINES :** 



## PELICAANBAK (MET GELASTE TANDEN)



- Gelaste WE-tanden.
- Verhandeling van materialen met een dichtheid  $\leq 1000$  kg/m<sup>3</sup>.
- Afneembare zijwanden, anti-morsbescherming en standaard uitgerust met vastgebouwde slijtstuk uit 500 HB .
- Versterkte constructie (basis, mes en grijper).
- Beschermd cilinders, alle assen met een "construction"afwerking.
- Robuust en veelzijdig bak bijzonder geschikt voor melkveebedrijven en andere landbouwtoepassingen.
- Volledige opening >90° en krachtige klauw om langs muurranden te kunnen werken.
- Perfect om losse mest, silage,... te verhandelen.
- Onmisbaar werktuig voor veeteeltbedrijven.





	BG 1500 / 600 WE	BG 1500 / 850 WE	BG 1850 / 1050 DA WE50 DA WE	BG 2100 / 1200 WE	BG 2300 / 1350 WE	BG 2450 / 1400 WE	BG 2450 / 1700 WE
Capaciteit (lb)	1212.54	1873.93	2334.70	2645.55	2943.17	3143.79	3736.84
Capaciteit van de koepel (US gal)	145.29	224.55	279.76	317.01	352.67	376.71	447.77
Slagcapaciteit (US gal)	89.82	137.63	171.71	195.49	214.77	229.30	303.80
Gewicht (lb)	842.17	1278.68	1534.42	1642.44	1730.63	1792.36	1973.14
Totale lengte (in)	3' 9"	4' 2"	4' 3"	4' 2"	4' 2"	4' 2"	4' 6"
Breedte (in)	4' 11"	4' 11"	6' 1"	6' 11"	7' 7"	8'	8'
Gesloten grijphoogte (in)	2' 7"	3' 5"	3' 5"	3' 5"	3' 5"	3' 5"	3' 8"
Geopende grijphoogte (in)	4' 9"	5' 10"	5' 10"	5' 10"	5' 10"	5' 10"	6' 6"
Machine-apparatuur	☐☐	☐☐	☐☐	☐☐	☐☐	☐☐	☐☐
Tanden	6	6	7	8	8	8	9
Minimum spreiding vorken (in)	11"	11"	11"	11"	1'	1' 1"	11"
Maximum spreiding vorken (in)	11"	11"	11"	11"	1'	1' 1"	11"
Slijtplaat met bouten (LDR)	Standaard	Standaard	Standaard	Standaard	Standaard	Standaard	Standaard
Hardheid slijtplaat	500	500	500	500	500	500	500

## Machine compatibiliteit

Referentienummer	-	52651959	52647326	52647328	52647330	52647332	52549720
Referentievorkenbord schranklader	-	52651960	-	-	-	-	-
All-Tach®	52736705	-	-	-	-	-	-
4 point Carriage	52742062	-	-	-	-	-	-
Euro Carriage	52742063	-	-	-	-	-	-
ALT950	-	-	-	-	X	X	X
GCT 3-14	X	-	-	-	-	-	-
GCT 3-14	X	-	-	-	-	-	-
GCT 3-14+	X	-	-	-	-	-	-
GCT 3-14 +	X	-	-	-	-	-	-
MLA-T 533-145 V+ - ST5	-	-	-	-	X	X	X
MLT 420-60 H	-	X	-	-	-	-	-
MLT 625-75 H	-	-	X	-	-	-	-
MLT 630-115	-	-	-	X	X	X	-
MLT 630-115 V	-	-	-	X	X	X	-
MLT 630-115 V CP	-	-	-	X	X	X	-
MLT 635-130 PS+	-	-	-	-	-	X	X
MLT 635-140 V+	-	-	-	-	-	X	X
MLT 730-115 V	-	-	-	X	X	X	-
MLT 730-115 V CP	-	-	-	X	X	X	-
MLT 733-115	-	-	-	-	-	X	X
MLT 733-115 LSU	-	-	-	-	-	X	X
MLT 737-130 PS+	-	-	-	-	-	X	X
MLT 841-145 PS+	-	-	-	-	-	X	X
MLT 850-145 V+	-	-	-	-	-	-	X
MLT 940-140 V+	-	-	-	-	-	X	X
MLT 1041-145 PS+L	-	-	-	-	-	X	X
MLT-X 625-75 H	-	-	X	-	-	-	-
MLT-X 732	-	-	-	-	-	X	-
MLT-X 735 T LSU	-	-	-	-	-	X	X

BG 1500 / 600 WE	BG 1500 / 850 WE	BG 1850 / 1050 DA WE50 DA WE	BG 2100 / 1200 WE	BG 2300 / 1350 WE	BG 2450 / 1400 WE	BG 2450 / 1700 WE
---------------------	---------------------	---------------------------------	----------------------	----------------------	----------------------	----------------------

Machine compatibiliteit							
MLT-X 737-130 PS+	-	-	-	-	-	X	X
MLT-X 741 T LSU	-	-	-	-	-	X	X
MLT-X 841 - 145 PS+	-	-	-	-	-	X	X
MLT-X 850-145 V+	-	-	-	-	-	-	X
MLT-X 1041-145 PS+L	-	-	-	-	-	X	X
ULM 412 H	X	-	-	-	-	-	-
ULM 412 H	X	-	-	-	-	-	-
ULM 415 H	X	-	-	-	-	-	-
ULM 415 H	X	-	-	-	-	-	-

VERPLICHTE UITRUSTING VAN MACHINES : 





## PELICAANBAK MET GROOT VOLUME



- Zeer slijtvaste mechanisch gelaste tanden -WE.
- Verhandeling van vrac materialen met een dichtheid  $\leq 1000$  kg /m<sup>3</sup>.
- Vastgebouten stalenstrip in 500 HB kwaliteit standaard.
- Versterkte bak : aanpassing van de zijtanden voor een beter aangrip van het material; verhoging van de afgestreken laadcapaciteit van de bak (1500 liter).
- Robuuste en veelzijdige bak ontworpen voor intensieve landbouwtoepassingen.
- Een aangepast werktuig om maximaal te kunnen renderen.
- Vervaardigd uit hoog resistent staal.
- Ideaal om graan, silage, hooi en andere bulkmaterialen te verhandelen.



	CBG 2480 / 2000 MS	CBG 2480 / 2600 MS
Capaciteit (lb)	4409.25	5732.02
Capaciteit van de koepel (US gal)	528.34	686.85
Slagcapaciteit (US gal)	396.26	396.26
Gewicht (lb)	2700.66	2991.67
Totale lengte (in)	4' 11"	5' 6"
Breedte (in)	8' 2"	8' 2"
Gesloten grijphoogte (in)	4' 11"	4' 11"
Geopende grijphoogte (in)	7' 6"	8' 1"
Machine-apparatuur		
Tanden	6	7
Minimum spreiding vorken (in)	1' 6"	1' 2"
Maximum spreiding vorken (in)	1' 6"	1' 2"
Hardheid slijtplaat	500	500

Machine compatibiliteit		
Referentienummer slijtplaat met bouten (LDR)	790656	790658
MLT 841-145 PS+	X	-
MLT 850-145 V+	X	X
MLT 961-160 V+ L	-	X
MLT 1041-145 PS+L	X	-
MLT-X 841 - 145 PS+	X	-
MLT-X 850-145 V+	X	X
MLT-X 961-160 V+ L	-	X
MLT-X 1041-145 PS+L	X	-





VERPLICHTE UITRUSTING VAN MACHINES : 



## PELIKAANBAK (COMPACTE MACHINES)



- Slijtmessen 400 HB.
- Zijdelingse slijtstukken in 400 HB voor een langere levensduur.
- Ontworpen voor alle landbouwtoepassingen.
- Veelzijdig werktuig: maakt het mogelijk om bulkmaterialen te verhandelen, materialen vast te grijpen, enz...

	BG 1200 / 430	BG 1400 / 510 (b)	BG 1650 FO	BG 1950 FO	BG 2150 FO
Capaciteit van de koepel (US gal)	113.59	134.73	174.35	206.05	229.83
Gewicht (lb)	590.84	606.27	782.64	881.85	936.96
Breedte (in)	3' 11"	4' 7"	5' 5"	6' 5"	7' 1"
Gesloten grijphoogte (in)	2' 9"	2' 9"	2' 9"	2' 9"	2' 9"
Diepte (in)	3' 3"	3' 3"	3' 2"	3' 2"	3' 2"
Machine-apparatuur					
Flexibele buis	Nee	Nee	Nee	Nee	Nee

Machine compatibiliteit					
All-Tach® Narrow	N51502263	-	-	-	-
All-Tach®	-	N51502266	N51502521	N51502520	N51502519
4 point Carriage	52799522	N51502278	N51502598	N51502600	N51502602
Euro Carriage	N51502286	N51502290	N51502557	N51502559	N51502561
AL530	-	X	-	-	-
AL650	X	-	X	X	-
AL750	-	-	X	X	X
MLA 5-50 H	-	X	-	-	-
MLA 6-65 H-Z	X	-	X	X	-
MLA 7-75 H-Z	-	-	X	X	X

**VERPLICHTE UITRUSTING VAN MACHINES :** 



## SCHEPBAK



- Breed gamma bakken met een capaciteit vanaf 600L.
- Bak aangepast om materialen te verhandelen met een dichtheid  $\leq 2,1$ .
- Versterkte structuur (basis, mes en zijanten).
- Vastgeboute slijtmes "LDR" in 500 HB in optie.
- TSDL : Bak te gebruiken op machines uitgerust met een geïntegreerde zijverstelling van het onderstel.
- De algemene bak voor een dagelijks gebruik.
- Basiswerktuig voor laad- en lostoepassingen.
- Robuust en eenvoudig te gebruiken. Beantwoordt aan heel wat verschillende eisen.
- Ideaal om bulkmaterialen te verhandelen: zand en losse steentjes, grond, gebroken glas, enz...

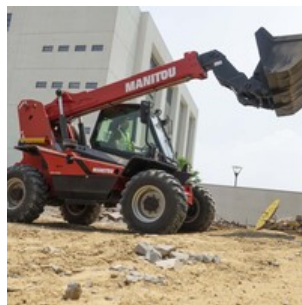

	CBR 600 / 1500	CBR 730 / 1850	CBR 780 / 1950	CBR 850 / 2100	CBR 900 / 2250	CBR 1000 / 2450	CBR 1000 / 2500
Capaciteit (lb)	2698.46	3401.73	3602.35	3902.18	4184.37	4583.41	4629.71
Capaciteit van de koepel (US gal)	154.01	194.17	205.53	222.70	238.81	261.53	264.17
Slagcapaciteit (US gal)	128.65	158.50	175.15	180.96	194.43	212.39	217.15
Gewicht (lb)	604.07	701.07	723.12	789.25	793.66	839.96	1463.87
Totale hoogte (in)	2' 7"	2' 7"	2' 7"	2' 7"	2' 7"	2' 7"	2' 8"
Totale lengte (in)	2' 9"	2' 8"	2' 8"	2' 9"	2' 8"	2' 8"	3' 2"
Breedte (in)	4' 11"	6' 1"	6' 5"	6' 11"	7' 5"	8'	8' 2"
Machine-apparatuur	×	×	×	×	×	×	×
Slijtplaat met bouten (LDR)	Niet standaard	Niet standaard	Niet standaard	Niet standaard	Niet standaard	Niet standaard	Standaard

## Machine compatibiliteit

Referentienummer	570614	571831	570613	653047	653749	654716	-
Referentienummer slijtplaat met bouten (LDR)	52584881	52000369	-	-	-	52000370	52645107
Referentienummer TSDL	-	-	-	-	52000365	52000366	-
Referentievorkenbord schranklader	52000783	-	-	-	-	-	-
ALT950	-	-	-	-	-	X	-
MLA-T 533-145 V+ - ST5	-	-	-	-	-	X	-
MLT 420-60 H	X	-	-	-	-	-	-
MLT 625-75 H	-	X	-	-	-	-	-
MLT 630-115	-	-	-	X	X	-	-
MLT 630-115 V	-	-	-	X	X	-	-
MLT 630-115 V CP	-	-	-	X	X	-	-
MLT 635-130 PS+	-	-	-	-	-	X	-
MLT 635-140 V+	-	-	-	-	-	X	-
MLT 730-115 V	-	-	-	X	X	-	-
MLT 730-115 V CP	-	-	-	X	X	-	-
MLT 733-115	-	-	-	-	-	X	-
MLT 733-115 LSU	-	-	-	-	-	X	-
MLT 737-130 PS+	-	-	-	-	-	X	-
MLT 741-130 PS+	-	-	-	-	-	X	-
MLT 741-140 V+	-	-	-	-	-	X	-
MLT 841-145 PS+	-	-	-	-	-	X	-
MLT 850-145 V+	-	-	-	-	-	X	-
MLT 940-140 V+	-	-	-	-	-	X	-
MLT 961-160 V+ L	-	-	-	-	-	-	X
MLT 1041-145 PS+L	-	-	-	-	-	X	-
MLT-X 625-75 H	-	X	-	-	-	-	-
MLT-X 732	-	-	-	-	-	X	-
MLT-X 735 T LSU	-	-	X	-	X	X	-
MLT-X 735 T LSU (70 KW)	-	-	-	-	-	X	-
MLT-X 737-130 PS+	-	-	-	-	-	X	-
MLT-X 741-140 V+	-	-	-	-	-	X	-
MLT-X 741 T LSU	-	-	-	-	-	X	-
MLT-X 841 - 145 PS+	-	-	-	-	-	X	-
MLT-X 850-145 V+	-	-	-	-	-	X	-



CBR 600 / 1500	CBR 730 / 1850	CBR 780 / 1950	CBR 850 / 2100	CBR 900 / 2250	CBR 1000 / 2450	CBR 1000 / 2500
----------------	----------------	----------------	----------------	----------------	-----------------	-----------------

Machine compatibiliteit							
MLT-X 961-160 V+ L	-	-	-	-	-	-	X
MLT-X 1041-145 PS+L	-	-	-	-	-	X	-
MT 420 H	X	-	-	-	-	-	-
MT 625 e	-	X	-	-	-	-	-
MT 625 HA	-	X	-	-	-	-	-
MT 730 H	-	-	X	-	-	-	-
MT 733 Easy	-	-	-	-	-	X	-
MT 735 75D ST5	-	-	-	-	X	X	-
MT 930 H	-	-	X	-	-	-	-
MT 930 HA	-	-	X	-	-	-	-
MT 933 Easy	-	-	-	-	X	X	-
MT 935 75D ST5	-	-	-	-	X	X	-
MT 1033 easy	-	-	-	-	X	X	-
MT 1135 75 D	-	-	-	-	X	X	-
MT 1135 H 100D	-	-	-	-	X	X	-
MT 1135 easy ST5	-	-	-	-	X	X	-
MT 1135 H easy ST5	-	-	-	-	X	X	-
MT 1135 HA Easy ST5	-	-	-	-	X	-	-
MT 1135 ST5	-	-	-	-	-	X	-
MT 1335 75D ST5	-	-	-	-	X	X	-
MT 1335 100D ST5	-	-	-	-	X	X	-
MT 1335	-	-	-	-	-	X	-
MT 1335 H 75D ST5	-	-	-	-	X	X	-
MT 1335 H 100D ST5	-	-	-	-	X	X	-
MT 1335 HA 75D ST5	-	-	-	-	X	X	-
MT 1335 HA 100D ST5	-	-	-	-	X	X	-
MT 1335 ST5	-	-	-	-	-	X	-
MT 1440 A	-	-	X	-	X	X	-
MT 1440 A ST5	-	-	-	-	-	X	-
MT 1440 easy ST5	-	-	-	-	-	X	-
MT 1440 HA	-	-	X	-	X	X	-
MT 1440 HA ST5	-	-	-	-	-	X	-
MT 1440 ST5	-	-	-	-	-	X	-
MT 1840 A 100D ST5 S1	-	-	-	-	-	X	-
MT 1840 A	-	-	-	-	X	X	-
MT 1840 easy ST5	-	-	-	-	-	X	-
MT 1840 HA	-	-	-	-	-	X	-
MT 1840 HA	-	-	-	-	X	X	-
MT 1840 ST5	-	-	-	-	-	X	-
MT-X 625 H	-	X	-	-	-	-	-
MT-X 733	-	-	-	-	-	X	-
MT-X 733 Mining	-	-	X	-	X	X	-
MT-X 1033	-	-	-	-	X	X	-
MT-X 1033 Mining	-	-	-	-	X	X	-

**CBR 600 / 1500** **CBR 730 / 1850** **CBR 780 / 1950** **CBR 850 / 2100** **CBR 900 / 2250** **CBR 1000 / 2450** **CBR 1000 / 2500**

Machine compatibiliteit							
MT-X 1033 A Mining	-	-	-	-	X	X	-
MT-X 1440	-	-	X	-	X	X	-
MT-X 1440 A	-	-	X	-	X	X	-
MT-X 1840	-	-	-	-	X	X	-
MT-X 1840 A	-	-	-	-	X	X	-

**VERPLICHTE UITRUSTING VAN MACHINES :** ✕



NEW

## SCHEPBAK - ESSENTIEEL

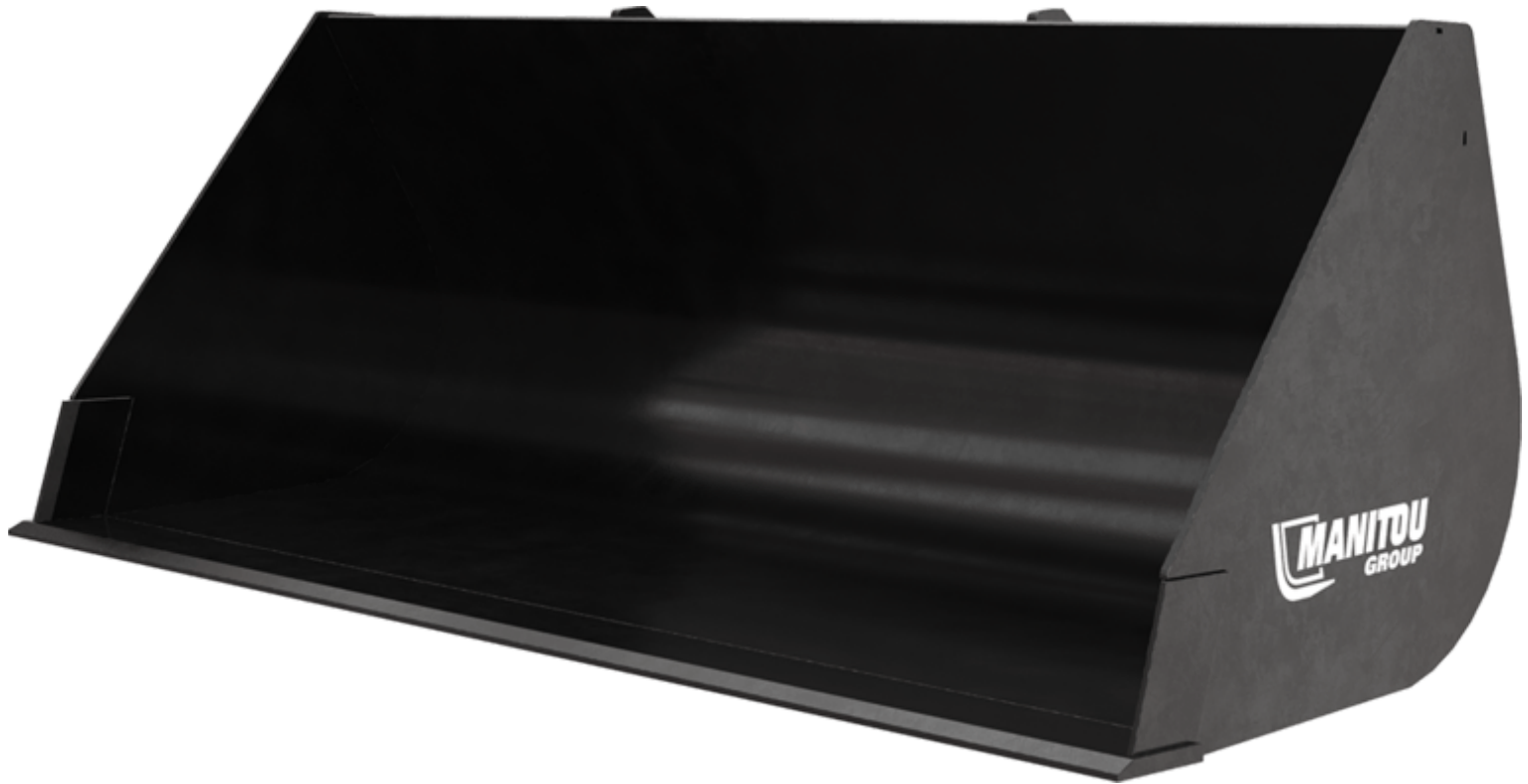

- Capacity: 400 up to 1000L.
- For material density up to 2100 kg/m<sup>3</sup>.
- Simplified structure with straight sides.
- Integrated level indicator.
- No side strengthener.
- A bucket for all construction applications.
- Dedicated to heavy bulk: sand, earth, stones, gravels, etc.
- Tested at the R&D Center on high demanding applications.
- Designed and validated by Manitou.



	BGP 1500 / 400 Essential	BGP 1850 / 750 Essential	BGP 2000 / 800 Essential	BGP 2300 / 900 Essential	BGP 2450 / 1000 Essential
Capaciteit (lb)	1823.22	3417.17	3712.58	4310.04	4605.46
Capaciteit van de koepel (US gal)	104.08	194.96	211.87	245.94	262.85
Slagcapaciteit (US gal)	82.16	151.63	164.32	189.68	202.36
Gewicht (lb)	354.94	718.71	760.59	835.55	875.24
Totale hoogte (in)	2' 1"	2' 7"	2' 7"	2' 7"	2' 7"
Totale lengte (in)	2' 8"	3' 2"	3'	3' 2"	3'
Breedte (in)	4' 11"	6' 1"	6' 7"	7' 7"	8'
Diepte (in)	2' 1"	2' 8"	2' 8"	2' 8"	2' 8"
Machine-apparatuur	×	×	×	×	×
Flexibele buis	-	-	Nee	-	-

## Machine compatibiliteit

Referentienummer	-	52690766	52688160	52690756	52658055
All-Tach®	52702290	-	-	-	-
4 point Carriage	52723638	-	-	-	-
Euro Carriage	52723639	-	-	-	-
GCT 3-14	X	-	-	-	-
GCT 3-14 +	X	-	-	-	-
MLT 630-115	-	-	X	-	-
MLT 630-115 V	-	-	X	-	-
MLT 630-115 V CP	-	-	X	-	-
MLT 635-130 PS+	-	-	-	-	X
MLT 635-140 V+	-	-	-	-	X
MLT 730-115 V	-	-	X	-	-
MLT 730-115 V CP	-	-	X	-	-
MLT 733-115	-	-	-	-	X
MLT 733-115 LSU	-	-	-	-	X
MLT 737-130 PS+	-	-	-	-	X
MLT 741-130 PS+	-	-	-	-	X
MLT 741-140 V+	-	-	-	-	X
MLT 841-145 PS+	-	-	-	-	X
MLT 940-140 V+	-	-	-	-	X
MLT 1041-145 PS+L	-	-	-	-	X
MLT-X 732	-	-	-	-	X
MLT-X 735 T LSU	-	-	-	-	X
MLT-X 735 T LSU (70 KW)	-	-	-	-	X
MLT-X 737-130 PS+	-	-	-	-	X
MLT-X 741-140 V+	-	-	-	-	X
MLT-X 741 T LSU	-	-	-	-	X
MLT-X 841 - 145 PS+	-	-	-	-	X
MLT-X 1035 LT LSU	-	-	-	-	X
MLT-X 1041-145 PS+L	-	-	-	-	X
MT 625 e	-	X	-	-	-
MT 625 HA	-	X	-	-	-
MT 730 H	-	-	X	-	-
MT 733 Easy	-	-	-	X	X

	BGP 1500 / 400 Essential	BGP 1850 / 750 Essential	BGP 2000 / 800 Essential	BGP 2300 / 900 Essential	BGP 2450 / 1000 Essential
<b>Machine compatibiliteit</b>					
MT 735 75D ST5	-	-	-	-	X
MT 930 H	-	-	X	-	-
MT 930 HA	-	-	X	-	-
MT 933 Easy	-	-	-	X	X
MT 935 75D ST5	-	-	-	-	X
MT 1033 easy	-	-	-	X	X
MT 1135 75 D	-	-	-	-	X
MT 1135 H 100D	-	-	-	-	X
MT 1135 easy ST5	-	-	-	X	X
MT 1135 H easy ST5	-	-	-	X	X
MT 1135 HA Easy ST5	-	-	-	X	X
MT 1135 ST5	-	-	-	X	X
MT 1335 75D ST5	-	-	-	-	X
MT 1335 100D ST5	-	-	-	-	X
MT 1335	-	-	-	X	X
MT 1335 easy ST5	-	-	-	X	X
MT 1335 H 75D ST5	-	-	-	-	X
MT 1335 H 100D ST5	-	-	-	-	X
MT 1335 H easy ST5	-	-	-	X	X
MT 1335 HA 75D ST5	-	-	-	-	X
MT 1335 HA 100D ST5	-	-	-	-	X
MT 1335 HA easy ST5	-	-	-	X	X
MT 1335 ST5	-	-	-	X	X
MT 1440 A	-	-	-	X	-
MT 1440 A ST5	-	-	-	X	X
MT 1440 easy ST5	-	-	-	X	X
MT 1440 HA	-	-	-	X	-
MT 1440 HA ST5	-	-	-	X	X
MT 1440 ST5	-	-	-	X	X
MT 1840 A 100D ST5 S1	-	-	-	X	X
MT 1840 A	-	-	-	X	-
MT 1840 easy ST5	-	-	-	X	X
MT 1840 HA	-	-	-	X	X
MT 1840 HA	-	-	-	X	-
MT 1840 ST5	-	-	-	X	X
MT-X 625 H	-	X	-	-	-
MT-X 733	-	-	-	X	X
MT-X 733 Mining	-	-	-	X	-
MT-X 1033	-	-	-	X	X
MT-X 1033 Mining	-	-	-	X	-
MT-X 1033 A Mining	-	-	-	X	-
MT-X 1440	-	-	-	X	X
MT-X 1440 A	-	-	-	X	X
MT-X 1840	-	-	-	X	X

BGP 1500 / 400 Essential	BGP 1850 / 750 Essential	BGP 2000 / 800 Essential	BGP 2300 / 900 Essential	BGP 2450 / 1000 Essential
-----------------------------	-----------------------------	-----------------------------	-----------------------------	------------------------------

Machine compatibiliteit					
MT-X 1840 A	-	-	-	X	X
ULM 412 H	X	-	-	-	-
ULM 412 H	X	-	-	-	-
ULM 415 H	X	-	-	-	-
ULM 415 H	X	-	-	-	-

VERPLICHTE UITRUSTING VAN MACHINES : ✕



## STANDAARD GRAAFBAK (COMPACTE MACHINES)

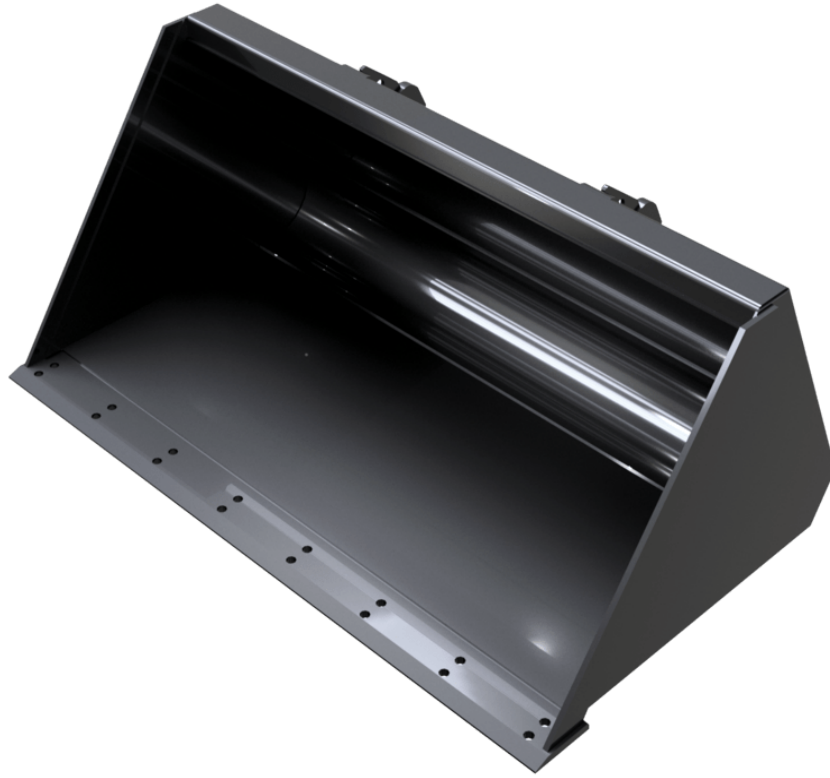

- 400 HB stalen versterkingen onder de bak.
- Robuuste bouw.

	BS 920 / 150	BS 1080 / 180	BS 1250 / 280	BS 1300 / 440	BS 1380 / 320	BS 1400 / 410	BS 1400 / 470
Capaciteit van de koepel (US gal)	39.63	47.55	73.97	116.24	84.54	108.31	124.16
Gewicht (lb)	110.23	121.25	295.42	418.88	302.03	396.83	447.54
Totale hoogte (in)	1' 5"	1' 5"	1' 7"	2' 5"	1' 7"	2' 3"	2' 5"
Breedte (in)	3'	3' 7"	4' 1"	4' 3"	4' 6"	4' 7"	4' 7"
Diepte (in)	2' 4"	2' 4"	2' 9"	2' 8"	2' 9"	2' 6"	2' 8"
Machine-apparatuur	×	×	×	×	×	×	×
Flexibele buis	Nee	Nee	Nee	Nee	Nee	Nee	Nee

Machine compatibiliteit							
All-Tach®	N726001	N726002	N736001	N004079	N736002	N004077	N004080
4 point Carriage	-	-	-	N003079	-	52807869	N003080
Euro Carriage	-	-	-	N51502179	-	N51502155	N51502180
850 R	X	X	-	-	-	-	-
1050 R	-	-	X	-	X	-	-
1050 RT	-	-	X	-	X	-	-
1350 R NXT2	-	-	-	-	X	-	-
1350 RT	-	-	X	-	X	-	-
1640 E	X	X	-	-	-	-	-
AL420	-	-	-	-	-	X	-
AL430	-	-	-	-	-	X	-
AL550	-	-	-	X	-	-	X
MLA 4-50 H	-	-	-	-	-	X	-
MLA 4-50 H-C	-	-	-	-	-	X	-
MLA 5-60 H-Z	-	-	-	X	-	-	X
R105	-	-	X	-	X	-	-
R135	-	-	-	-	X	-	-
RT105	-	-	X	-	X	-	-
RT135	-	-	-	-	X	-	-

**VERPLICHTE UITRUSTING VAN MACHINES :** ×



	BS 1480 / 340	BS 1500 / 510	BS 1520 / 350	BS 1550 / 360	BS 1650 / 730	BS 1680 / 400	BS 1680 / 480
Capaciteit van de koepel (US gal)	89.82	134.73	92.46	95.10	192.85	105.67	126.80
Gewicht (lb)	310.85	476.20	315.26	330.69	584.22	326.28	414.47
Totale hoogte (in)	1' 7"	2' 5"	1' 7"	1' 7"	2' 5"	1' 6"	1' 8"
Breedte (in)	4' 10"	4' 11"	5'	5' 1"	5' 5"	5' 6"	5' 6"
Diepte (in)	2' 9"	2' 8"	2' 9"	2' 9"	3' 4"	2' 9"	3'
Machine-apparatuur	×	×	×	×	×	×	×
Flexibele buis	Nee	Nee	Nee	Nee	Nee	Nee	Nee

Machine compatibiliteit							
All-Tach®	N736061	N004081	N736003	N736065	N51502506	N747002	N51502457
4 point Carriage	-	N003081	-	-	N51502611	-	-
Euro Carriage	-	N51502181	-	-	N51502570	-	-
1050 R	X	-	-	-	-	-	-
1050 RT	X	-	-	-	-	-	-
1350 R NXT2	X	-	X	X	-	-	-
1350 RT	X	-	X	X	-	-	-
1650 R	-	-	-	-	-	X	-
1650 RT	-	-	-	X	-	X	-
1900 R	-	-	-	-	-	-	X
2100V	-	-	-	-	-	-	X
2100VT	-	-	-	-	-	X	-
AL550	-	X	-	-	-	-	-
AL650	-	-	-	-	X	-	-
AL750	-	-	-	-	X	-	-
MLA 5-60 H-Z	-	X	-	-	-	-	-
MLA 6-65 H-Z	-	-	-	-	X	-	-
MLA 7-75 H-Z	-	-	-	-	X	-	-
R105	X	-	-	-	-	-	-
R135	X	-	X	-	-	-	-
R165	-	-	-	-	-	X	-
R190	-	-	-	-	-	-	X
RT105	X	-	-	-	-	-	-
RT135	X	-	X	X	-	-	-
RT165	-	-	-	X	-	X	-
V210 - NEW	-	-	-	-	-	-	X
VT210 - NEW	-	-	-	-	-	X	-

VERPLICHTE UITRUSTING VAN MACHINES : ✕

	BS 1680 / 670	BS 1760 / 500	BS 1760 / 580	BS 1760 / 700	BS 1800 / 800	BS 1830 / 520	BS 1830 / 600
Capaciteit van de koepel (US gal)	177	153.22	132.09	184.92	211.34	158.50	137.37
Gewicht (lb)	650.36	418.88	418.88	672.41	628.32	485.02	454.15
Totale hoogte (in)	2'	2' 8"	1' 8"	2'	2' 5"	1' 8"	1' 8"
Breedte (in)	5' 6"	5' 9"	5' 9"	5' 9"	5' 11"	6'	6'
Diepte (in)	3' 7"	3'	3'	3' 7"	3' 4"	3'	3'
Machine-apparatuur	×	×	×	×	×	×	×
Flexibele buis	Nee	Nee	Nee	Nee	Nee	Nee	Nee

Machine compatibiliteit							
All-Tach®	N51502021	N51502459	N748001	N51502022	N51502505	N51502461	N757073
4 point Carriage	-	-	-	-	N51502614	-	-
Euro Carriage	-	-	-	-	N51502573	-	-
1650 R	-	-	X	-	-	-	-
1650 RT	-	-	X	-	-	-	-
1850 RT	X	-	-	X	-	-	-
1900 R	-	X	-	-	-	-	-
2100V	-	X	X	-	-	-	-
2100VT	-	-	X	-	-	-	-
2200 R	-	X	-	-	-	X	-
2300V	-	X	X	-	-	X	-
2300VT	X	-	-	X	-	-	-
2600 R	-	-	-	-	-	X	-
2700 V NXT:2	-	-	X	-	-	-	X
2750V	-	-	X	-	-	-	X
2750VT	-	-	-	X	-	-	-
AL650	-	-	-	-	X	-	-
AL750	-	-	-	-	X	-	-
MLA 6-65 H-Z	-	-	-	-	X	-	-
MLA 7-75 H-Z	-	-	-	-	X	-	-
R165	-	-	X	-	-	-	-
R190	-	X	-	-	-	-	-
R220	-	X	-	-	-	X	-
R260	-	-	-	-	-	X	-
RT165	-	-	X	-	-	-	-
RT185	X	-	-	X	-	-	-
V210 - NEW	-	X	X	-	-	-	-
V230 - NEW	-	X	X	-	-	X	-
V270	-	-	X	-	-	-	X
V275 - NEW	-	-	X	-	-	-	X
VT210 - NEW	-	-	X	-	-	-	-
VT230 - NEW	X	-	-	X	-	-	-
VT275 - NEW	-	-	-	X	-	-	-

**VERPLICHTE UITRUSTING VAN MACHINES :** ×

	BS 1850 / 740	BS 1880 / 750	BS 1950 / 860	BS 2140 / 870 (a)	BS 2140 / 870 (b)	BS 2150 / 950
Capaciteit van de koepel (US gal)	195.49	198.13	229.83	229.83	229.83	253.61
Gewicht (lb)	694.46	694.46	661.39	705.48	507.06	734.14
Totale hoogte (in)	2'	2'	2' 5"	2'	2'	2' 5"
Breedte (in)	6' 1"	6' 2"	6' 5"	7'	7'	7' 1"
Diepte (in)	3' 7"	3' 7"	3' 4"	3' 7"	3' 7"	3' 4"
Machine-apparatuur	×	×	×	×	×	×
Flexibele buis	Nee	Nee	Nee	Nee	Nee	Nee

Machine compatibiliteit						
All-Tach®	N51502023	N51502071	N51502547	N700244	N51502024	N51502546
4 point Carriage	-	-	N51502617	-	-	N51502620
Euro Carriage	-	-	N51502576	-	-	N51502579
1850 RT	X	-	-	-	-	-
2150 RT	X	-	-	-	X	-
2300VT	X	-	-	-	-	-
2600 R	-	X	-	-	-	-
2750V	-	X	-	-	-	-
2750VT	-	-	-	-	X	-
3300 V NXT:2	-	X	-	X	-	-
4200 V	-	-	-	X	-	-
AL650	-	-	X	-	-	-
AL750	-	-	X	-	-	X
MLA 6-65 H-Z	-	-	X	-	-	-
MLA 7-75 H-Z	-	-	X	-	-	X
R260	-	X	-	-	-	-
RT185	X	-	-	-	-	-
RT215	X	-	-	-	X	-
V275 - NEW	-	X	-	-	-	-
V330	-	X	-	X	-	-
VT230 - NEW	X	-	-	-	-	-
VT275 - NEW	-	-	-	-	X	-

**VERPLICHTE UITRUSTING VAN MACHINES :** ×





## UITKUILBAK



- Gesynchroniseerde hydraulische bewegingen.
- Hydromotor geïntegreerd in de rotor: maximale bescherming en levensduur.
- Rotatie van de rotor naar achteren om de bak beter te vullen.
- Slijtmes 500 HB.
- Verhandeling van materialen met een dichtheid  $\leq 1000$  kg/m<sup>3</sup>.
- Om in één beweging silage uit te kuilen en te verluchten. Vergemakelijkt de werking van mengwagens.
- Kant-en-klare silage: rechtstreekse verdeling of om een voedermengwagen te vullen.
- Glad snijeffect voor de kuil, om opwarmingen te beperken.
- Eén enkele werktuig om zowel silage als kernvoeders te verhandelen om tijd te winnen.
- Voor ingekuilde maïs en kort gesneden groenvoeders. Voldoet niet voor silage dat langer gesneden is (10 cm max.).



	BSCR 2100 / 1130	CRS 2350 / 1800	CRS 2550 / 2000
Capaciteit (lb)	2491.22	3968.32	4409.25
Capaciteit van de koepel (US gal)	298.51	475.51	528.34
Gewicht (lb)	1190.50	1984.16	2105.41
Breedte (in)	6' 11"	7' 9"	8' 4"
Machine-apparatuur			

## Machine compatibiliteit

Referentienummer	52728902	52612542	52612540
MLT 625-75 H	X	-	-
MLT 630-115	-	X	-
MLT 630-115 V	-	X	-
MLT 630-115 V CP	-	X	-
MLT 635-130 PS+	-	-	X
MLT 635-140 V+	-	-	X
MLT 730-115 V	-	X	-
MLT 730-115 V CP	-	X	-
MLT 733-115	-	-	X
MLT 733-115 LSU	-	-	X
MLT 737-130 PS+	-	-	X
MLT 841-145 PS+	-	-	X
MLT 940-140 V+	-	-	X
MLT 1041-145 PS+L	-	-	X
MLT-X 625-75 H	X	-	-
MLT-X 732	-	-	X
MLT-X 735 T LSU	-	-	X
MLT-X 737-130 PS+	-	-	X
MLT-X 741 T LSU	-	-	X
MLT-X 841 - 145 PS+	-	-	X
MLT-X 1041-145 PS+L	-	-	X

**VERPLICHTE UITRUSTING VAN MACHINES :**  + 



## VOLUMEBAK

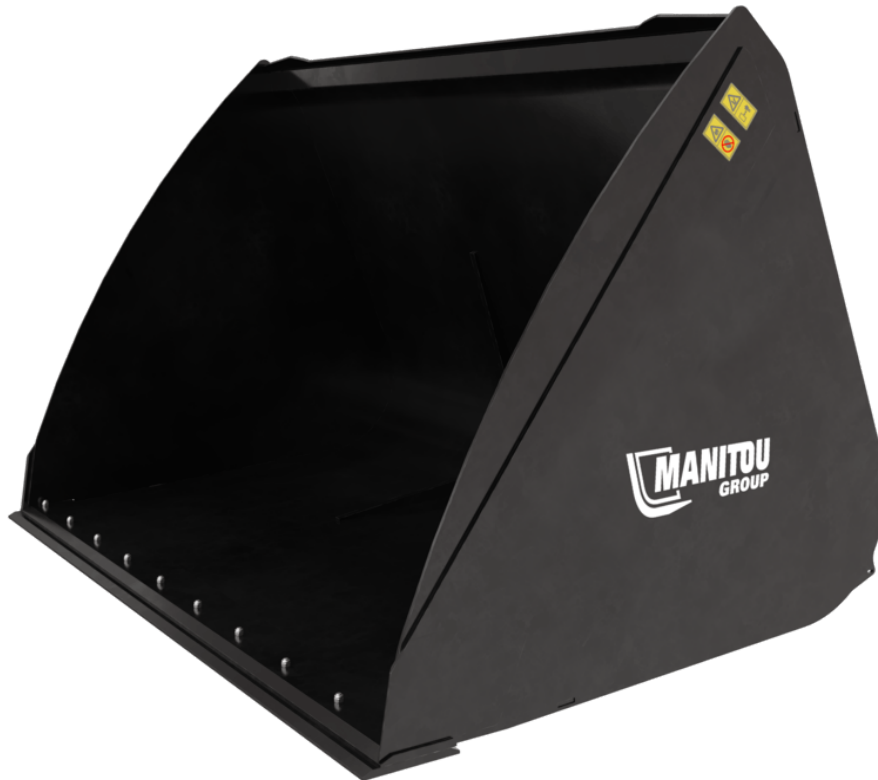

- Bak bestemd om materialen te verhandelen met een densiteit  $\leq 1$ .
- Versterkte structuur (basis, mes en zijkanen).
- Прочный и универсальный ковш, подходящий для использования в молочном производстве и других направлениях сельского хозяйства.
- Полное раскрытие ковша  $>90^\circ$  и мощный захват позволяют работать вплотную к стене.
- Идеально подходит для работ с жидким навозом, силосом и т. д.
- Незаменимое оборудование для животноводческой фермы.



	CBA 2500 / 4000 LDR	CBA 2700 / 4500 LDR
Capaciteit (lb)	7065.82	8024.83
Capaciteit van de koepel (US gal)	1058.54	1201.98
Slagcapaciteit (US gal)	844.03	955.51
Gewicht (lb)	2888.06	3086.47
Totale hoogte (in)	5' 4"	5' 6"
Totale lengte (in)	6' 3"	6' 3"
Breedte (in)	8' 2"	8' 10"
Diepte (in)	5' 7"	5' 7"
Machine-apparatuur	×	×
Hardheid slijtplaat	500	500

Machine compatibiliteit		
Referentienummer slijtplaat met bouten (LDR)	52603178	52000508
MLT 850-145 V+	X	X
MLT 961-160 V+ L	X	X
MLT-X 850-145 V+	X	X
MLT-X 961-160 V+ L	X	X

**VERPLICHTE UITRUSTING VAN MACHINES :** ×



## VOLUMEBAK



- Breed gamma bakken met een capaciteit van 900 L tot 3000 L.
- Landbouwbak aangepast om materialen te verhandelen met een dichtheid  $\leq 1$ .
- Versterkte structuur (basis, mes en zijanten).
- De DA tekening vermeldt dat de uitkiphoek met  $10^\circ$  verbeterd werd.
- In optie : omkeerbaar mes 500HB voor een nog langere levensduur (1).
- Bak aangepast voor een dagelijks en intensief gebruik.
- Ideaal om bulkmaterialen (graan, houtsnippers, kernvoeders) te verhandelen.
- Duurzaam en sterk werktuig.
- Verbeterde vorm om sneller te kunnen laden en lossen.
- Verhoogde levensduur dankzij de slijtstrip.





	CBA 900 / 1500	CBA 1500 / 2050	CBA 1500 / 2050 DA	CBA 1500 / 2450	CBA 1700L / 2100
Capaciteit (lb)	1953.30	3306.93	3306.93	3370.87	3754.47
Capaciteit van de koepel (US gal)	234.06	396.26	396.26	403.92	449.89
Slagcapaciteit (US gal)	177.52	290.85	290.85	290.85	335.76
Gewicht (lb)	809.10	1080.27	1062.63	1102.31	1128.77
Totale hoogte (in)	3' 5"	3' 8"	3' 8"	3' 3"	3' 9"
Totale lengte (in)	3' 9"	3' 9"	3' 9"	3' 10"	3' 11"
Breedte (in)	4' 11"	6' 9"	6' 9"	8'	6' 11"
Machine-apparatuur	×	×	×	×	×

## Machine compatibiliteit

Referentienummer	570543	570546	653035	570547	570549
Referentienummer slijtplate met bouten (LDR)	-	-	52000489	570548	52610570
Referentievorkenbord schranklader	52658300	-	-	-	-
ALT950	-	-	-	X	-
MLA-T 533-145 V+ - ST5	-	-	-	X	-
MLT 420-60 H	X	-	-	-	-
MLT 625-75 H	-	X	X	-	-
MLT 630-115	-	-	-	X	X
MLT 630-115 V	-	-	-	X	X
MLT 630-115 V CP	-	-	-	X	X
MLT 635-130 PS+	-	-	-	X	-
MLT 635-140 V+	-	-	-	X	-
MLT 730-115 V	-	-	-	X	X
MLT 730-115 V CP	-	-	-	X	X
MLT 733-115	-	-	-	X	X
MLT 733-115 LSU	-	-	-	X	X
MLT 737-130 PS+	-	-	-	X	X
MLT 741-130 PS+	-	-	-	X	X
MLT 741-140 V+	-	-	-	X	X
MLT-X 625-75 H	-	X	X	-	-
MLT-X 732	-	-	-	X	-
MLT-X 735 T LSU	-	-	-	X	-
MLT-X 735 T LSU (70 KW)	-	-	-	X	-
MLT-X 737-130 PS+	-	-	-	X	X
MLT-X 741-140 V+	-	-	-	X	X
MLT-X 1035 LT LSU	-	-	-	X	-

**VERPLICHTE UITRUSTING VAN MACHINES :** ×

	CBA 2000 / 2450	CBA 2000L / 2250	CBA 2500L / 2450	CBA 3000 / 2500
Capaciteit (lb)	4431.29	4343.11	5568.88	6664.57
Capaciteit van de koepel (US gal)	530.99	520.42	667.30	798.59
Slagcapaciteit (US gal)	392.03	384.63	506.15	618.69
Gewicht (lb)	1227.97	1289.70	1488.12	1660.08
Totale hoogte (in)	3' 9"	3' 7"	4' 1"	4' 4"
Totale lengte (in)	3' 11"	4' 8"	4' 11"	5' 8"
Breedte (in)	8'	7' 5"	8'	8' 2"
Machine-apparatuur	×	×	×	×

## Machine compatibiliteit

Referentienummer	570551	790540	570553	570555
Referentienummer slijtplate met bouten (LDR)	570552	790541	570554	500701
Referentievorkenbord schranklader	-	-	-	-
ALT950	X	X	-	-
MLA-T 533-145 V+ - ST5	X	X	-	-
MLT 630-115	X	X	-	-
MLT 630-115 V	X	X	-	-
MLT 630-115 V CP	X	X	-	-
MLT 635-130 PS+	X	-	X	-
MLT 635-140 V+	X	-	X	-
MLT 730-115 V	X	X	-	-
MLT 730-115 V CP	X	X	-	-
MLT 733-115	X	X	X	-
MLT 733-115 LSU	X	X	X	-
MLT 737-130 PS+	X	X	X	X
MLT 741-130 PS+	X	X	X	X
MLT 741-140 V+	X	X	X	X
MLT 841-145 PS+	X	-	X	X
MLT 850-145 V+	-	-	X	X
MLT 940-140 V+	X	-	X	X
MLT 1041-145 PS+L	X	-	X	X
MLT-X 732	X	-	X	-
MLT-X 735 T LSU	X	-	X	-
MLT-X 735 T LSU (70 KW)	-	-	X	-
MLT-X 737-130 PS+	X	X	X	-
MLT-X 741-140 V+	X	X	X	X
MLT-X 741 T LSU	X	-	X	X
MLT-X 841 - 145 PS+	X	-	X	X
MLT-X 850-145 V+	-	-	X	X
MLT-X 1035 LT LSU	-	-	X	-
MLT-X 1041-145 PS+L	X	-	X	X

**VERPLICHTE UITRUSTING VAN MACHINES :** ×



## WASTE BAK



- Vervaardigd uit hoog resistent staal: stalenversteigers S355, glijlofften en vastgeboute mesgedeelte uit 500 HB.
  - Hoek van 3° tussen het vastgeboutemesgedeelte en de bodem van de bak voor een langere levensduur.
  - Massief opbouw aangepast aan de werkomstandigheden in de recyclagewereld (basis, bodem, aankoppeling, versterkingen, enz...).
  - Geïntegreerde klep om afvalverlies te beperken bij het leegkippen van de bak.
- Vervaardigd uit hoog resistent staal: stalenversteigers S355, glijlofften en vastgeboute mesgedeelte uit 500 HB.
  - Hoek van 3° tussen het vastgeboutemesgedeelte en de bodem van de bak voor een langere levensduur.
  - Massief opbouw aangepast aan de werkomstandigheden in de recyclagewereld (basis, bodem, aankoppeling, versterkingen, enz...).
  - Geïntegreerde klep om afvalverlies te beperken bij het leegkippen van de bak.



	BEN 2500 / 3000 WP	CBA 2450 / 2200 EN	CBA 2500 / 3200 EN
Capaciteit (lb)	6393.41	4903.08	7048.18
Capaciteit van de koepel (US gal)	766.10	587.52	844.56
Slagcapaciteit (US gal)	607.60	362.18	656.47
Gewicht (lb)	2270.76	2008.41	2447.13
Totale hoogte (in)	4' 4"	4'	4' 8"
Totale lengte (in)	5' 9"	4' 11"	5' 8"
Breedte (in)	8' 2"	8'	8' 2"
Machine-apparatuur	×	×	×
Slijtplaat met bouten (LDR)	Standaard	Standaard	Standaard
Hardheid slijtplaat	500	500	500

Machine compatibiliteit			
Referentienummer	52736126	52000524	52000125
ALT950	-	X	-
MLA-T 533-145 V+ - ST5	-	X	-
MLT 635-130 PS+	-	X	-
MLT 635-140 V+	-	X	-
MLT 733-115	-	X	-
MLT 733-115 LSU	-	X	-
MLT 737-130 PS+	-	X	-
MLT 741-130 PS+	-	X	-
MLT 741-140 V+	-	X	-
MLT 841-145 PS+	-	X	-
MLT 850-145 V+	X	-	X
MLT 961-160 V+ L	-	-	X
MLT 1041-145 PS+L	-	X	-
MLT-X 737-130 PS+	-	X	-
MLT-X 741-140 V+	-	X	-
MLT-X 741 T LSU	-	X	-
MLT-X 841 - 145 PS+	-	X	-
MLT-X 850-145 V+	X	-	X
MLT-X 961-160 V+ L	-	-	X
MLT-X 1041-145 PS+L	-	X	-

**VERPLICHTE UITRUSTING VAN MACHINES :** ×



# KLEMMEN

## Bereik



- 63 Balenklem
- 65 Balenklem intensief
- 67 Balenklem voor intensief gebruik
- 69 Balenklem voor rechthoekige balen
- 71 Gewikkelde balenklem (compacte machines)
- 73 Klassieke balenklem
- 75 Multifunctionele balenklem

- 77 potklem
- 79 Pottenklem (compacte machines)
- 81 Ronde balenklem (compacte machines)
- 83 Super compacte balenklem
- 85 Vierkante balenklem
- 87 Vierkante balenklem (compacte machines)





## BALENKLEM



- Zelfgesmeerde anti-slijtage ring voor een verhoogde levensduur van het werktuig.
- Uitstekende hefcapaciteit van 800 kg tot 1500 kg.
- Gelast onderstel uit één stuk.
- CLBW 800 : om gewikkelde balen met een diameter van 0.85 m tot 1.45 m te verhandelen.
- CLBW 1500 : om gewikkelde balen met een diameter van 1 m tot 1.7 m te verhandelen.
- Capacita visivelmente a altura de elevação da máquina (+ 800 mm ou mais).
- Melhora a eficiência das aplicações de carregamento de caminhões / contêineres.



	CLBW 800	CLBW 1500
Capaciteit (lb)	1763.70	3306.93
Gewicht (lb)	500.45	553.36
Totale hoogte (in)	2' 8"	2' 8"
Totale lengte (in)	4' 7"	4' 11"
Breedte (in)	5' 2"	5' 2"
Machine-apparatuur		
Opening minimum (in)	10"	1' 8"
Opening maximum (in)	4' 11"	6' 1"
1 Verpakte baal maximale diameter (in)	4' 9"	5' 7"
1 Ronde baal minimale diameter (in)	2' 9"	3' 3"

Machine compatibiliteit		
Referentienummer	52000813	52001012
ALT950	-	X
MLA-T 533-145 V+ - ST5	-	X
MLT 420-60 H	X	X
MLT 625-75 H	X	X
MLT 630-115	X	X
MLT 630-115 V	X	X
MLT 630-115 V CP	X	X
MLT 635-130 PS+	X	X
MLT 635-140 V+	X	X
MLT 730-115 V	X	X
MLT 730-115 V CP	X	X
MLT 733-115	X	X
MLT 733-115 LSU	X	X
MLT 737-130 PS+	X	X
MLT 741-130 PS+	X	X
MLT 741-140 V+	X	X
MLT 841-145 PS+	-	X
MLT 850-145 V+	-	X
MLT 940-140 V+	X	X
MLT 961-160 V+ L	-	X
MLT 1041-145 PS+L	X	X
MLT-X 625-75 H	X	X
MLT-X 732	X	X
MLT-X 735 T LSU	X	X
MLT-X 737-130 PS+	X	X
MLT-X 741-140 V+	X	X
MLT-X 741 T LSU	-	X
MLT-X 841 - 145 PS+	-	X
MLT-X 850-145 V+	-	X
MLT-X 961-160 V+ L	-	X
MLT-X 1035 LT LSU	-	X
MLT-X 1041-145 PS+L	X	X

**VERPLICHTE UITRUSTING VAN MACHINES :** 





## BALENKLEM INTENSIEF



- Tandens 2x6.
- Gesynchroniseerde sluiting.
- Uitstekende hefcapaciteit van 2000 kg aan 800 mm of 2500 met onderste tanden in optie.
- Om 1 ronde baal  $\varnothing$  1,8 m max te verhandelen voor de 2x4 en  $\varnothing$  1,5 tot 2 m voor de 2x3.
- Om 2 rechthoekige balen met een maximale hoogte van 0,8 m per baal te verhandelen.
- Eenvoudig te gebruiken en doeltreffend werktuig.
- Om tot 2 ronde balen of 3 rechthoekige balen tegelijk te verhandelen.
- Gebogen en gesmede tanden bieden een nauwkeurige en propere snijeffect in het materiaal.

	CLBR 2x6
Capaciteit (lb)	4409.25
Gewicht (lb)	956.81
Totale hoogte (in)	7' 5"
Totale lengte (in)	4' 2"
Lengte vorken (in)	1' 1"
Breedte (in)	3' 3"
Lengte armen (in)	2' 4"
Machine-apparatuur	
Tanden / Vingers	2 / 6
Opening minimum (in)	7"
Opening maximum (in)	6' 5"

Machine compatibiliteit	
Referentienummer	757666
MLT 635-130 PS+	X
MLT 635-140 V+	X
MLT 733-115	X
MLT 733-115 LSU	X
MLT 737-130 PS+	X
MLT 741-130 PS+	X
MLT 741-140 V+	X
MLT 841-145 PS+	X
MLT 850-145 V+	X
MLT 940-140 V+	X
MLT 1041-145 PS+L	X
MLT-X 737-130 PS+	X
MLT-X 741-140 V+	X
MLT-X 741 T LSU	X
MLT-X 841 - 145 PS+	X
MLT-X 850-145 V+	X
MLT-X 1041-145 PS+L	X

**VERPLICHTE UITRUSTING VAN MACHINES :** 



## BALENKLEM VOOR INTENSIEF GEBRUIK



- Gesmeede en afgeronde tanden 2x4.
- Gesynchroniseerde sluiting.
- Uitstekende hefcapaciteit van 1800 kg.
- Om 1 of 2 ronde balen met een maximaal diameter van 1,8 m te verhandelen.
- Om 2 rechthoekige balen met een hoogte van elk 1,2 m te verhandelen.
- Om 3 rechthoekige balen met een hoogte van elk 0,8 m te verhandelen.
- In optie: tandhouder bajonet 2 tanden 680 mm Ø 35 mm ref. 790521 - kit service wisselstukken.
- Eenvoudig en efficiënt accessoire.
- De afgeronde tanden zorgen voor een precieze en propere penetratie in de baal.
- Grijpt 2 ronde balen of 3 rechthoekige tegelijkertijd.
- Een drager met bajonettanden zorgt voor een excellente stabiliteit bij het manipuleren van rechthoekige balen.



	Lower Tines	P2BG 2x4
Capaciteit (lb)	-	3968.32
Gewicht (lb)	77.16	623.91
Totale hoogte (in)	-	5' 10"
Totale lengte (in)	2' 3"	3' 5"
Kabellus	-	1
Breedte (in)	-	3' 7"
Lengte armen (in)	-	2'
Diameter (in)	1"	-
Machine-apparatuur	-	
Tanden / Vingers	2	2 / 4
Opening minimum (in)	-	6"
Opening maximum (in)	-	5' 10"

Machine compatibiliteit		
Referentienummer	790521	790518
ALT950	X	X
MLA-T 533-145 V+ - ST5	X	X
MLT 630-115	X	X
MLT 630-115 V	X	X
MLT 630-115 V CP	X	X
MLT 730-115 V	X	X
MLT 730-115 V CP	X	X
MLT 733-115	X	X
MLT 733-115 LSU	X	X
MLT 737-130 PS+	X	X
MLT 741-130 PS+	X	X
MLT 741-140 V+	X	X
MLT 841-145 PS+	X	X
MLT 850-145 V+	X	X
MLT 961-160 V+ L	X	X
MLT 1041-145 PS+L	X	X
MLT-X 732	X	X
MLT-X 735 T LSU	X	X
MLT-X 735 T LSU (70 KW)	X	X
MLT-X 737-130 PS+	X	X
MLT-X 741-140 V+	X	X
MLT-X 741 T LSU	-	X
MLT-X 841 - 145 PS+	X	X
MLT-X 850-145 V+	X	X
MLT-X 961-160 V+ L	X	X
MLT-X 1035 LT LSU	X	X
MLT-X 1041-145 PS+L	X	X

**VERPLICHTE UITRUSTING VAN MACHINES :** 



## BALENKLEM VOOR RECHTHOEKIGE BALEN



- Robuuste kader en componenten voor intensieve toepassingen.
- Telescoop kinematiek - zachte bewegingen en hogere knijpkracht.
- Gebruik van Téflon® beklede kussentjes - Beperkt onderhoud.
- Standaard met drukbegrenzer.
- Buisvormige structuur - geen enkel risico op schade aan de folie bij de verplaatsing van gewikkelde balen.
- Grote opening van de klem om grote balen of verschillende gangbare balen te verhandelen.
- Hogere bescherming van de componenten.
- Multi inzetbaar: ontworpen voor rechthoekige gewikkelde balen, kan ook worden gebruikt voor standaard rechthoekige balen of ronde balen.



	CLBSW 2000 / 1000
Capaciteit (lb)	2204.62
Gewicht (lb)	1064.83
Totale hoogte (in)	2' 3"
Totale lengte (in)	6' 1"
Breedte (in)	5'
Lengte armen (in)	3' 3"
Machine-apparatuur	
Opening minimum (in)	2' 5"
Opening maximum (in)	6' 10"

Machine compatibiliteit	
Referentienummer	52000812
MLT 625-75 H	X
MLT 630-115	X
MLT 630-115 V	X
MLT 630-115 V CP	X
MLT 635-130 PS+	X
MLT 635-140 V+	X
MLT 730-115 V	X
MLT 730-115 V CP	X
MLT 733-115	X
MLT 733-115 LSU	X
MLT 737-130 PS+	X
MLT 741-130 PS+	X
MLT 741-140 V+	X
MLT 841-145 PS+	X
MLT 850-145 V+	X
MLT 940-140 V+	X
MLT 961-160 V+ L	X
MLT 1041-145 PS+L	X
MLT-X 625-75 H	X
MLT-X 735 T LSU	X
MLT-X 737-130 PS+	X
MLT-X 741-140 V+	X
MLT-X 741 T LSU	X
MLT-X 841 - 145 PS+	X
MLT-X 850-145 V+	X
MLT-X 961-160 V+ L	X
MLT-X 1041-145 PS+L	X

VERPLICHTE UITRUSTING VAN MACHINES : 



## GEWIKKELDE BALENKLEM (COMPACTE MACHINES)

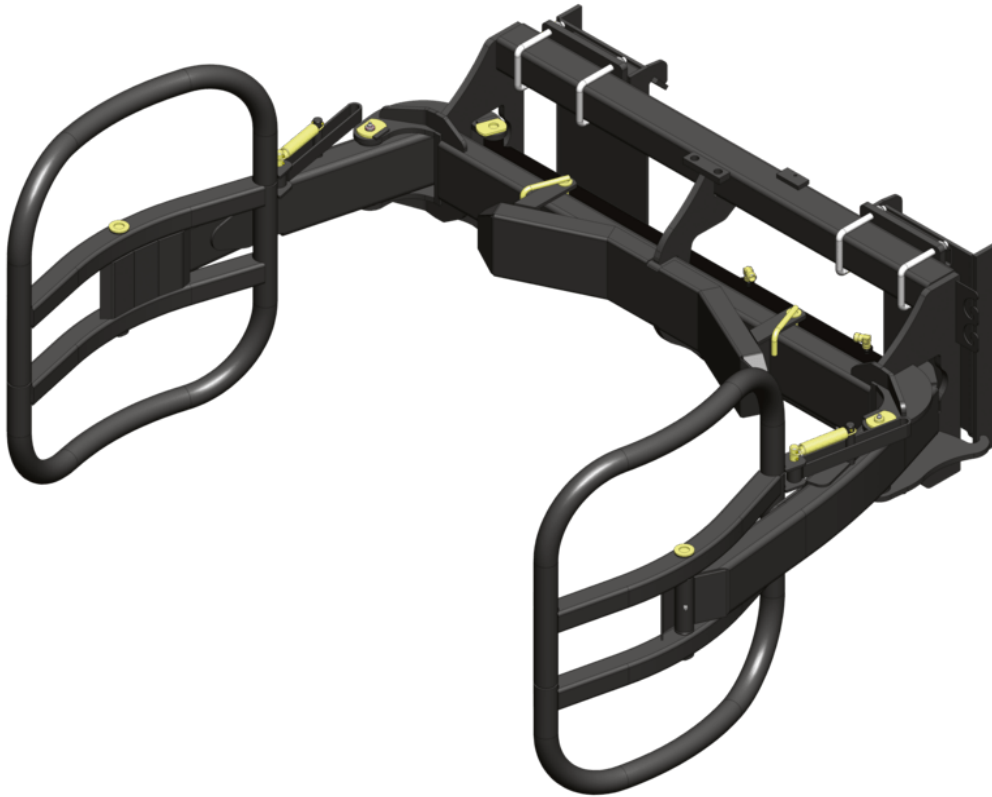

- Zelfgesmeerde antisluitage ring voor een langere levensduur van het werktuig.
- Uitstekende hefcapaciteit van 1000 kg.
- Gelast onderstel uit één stuk.
- Om gewikkelde balen met een diameter van 1 m tot 1,7 m te verhandelen.
- Eenvoudig te gebruiken en doeltreffend werktuig.
- Robuust dubbelwerkend cilinder om de zwaarste balen te verhandelen.
- Afgeronde en knikklem om de vorm van elke baal na te bootsen.
- Gladde structuur om wikkelfolie optimaal te beschermen.

	CLBW 800
Capaciteit (lb)	1763.70
Gewicht (lb)	500.45
Totale hoogte (in)	2' 8"
Totale lengte (in)	4' 4"
Breedte (in)	5' 2"
Diameter minimum / Diameter maximum (in)	2' 8" / 4' 11"
Machine-apparatuur	
Opening minimum (in)	10"
Opening maximum (in)	3' 5"

Machine compatibiliteit	
All-Tach® Narrow	N51502697
All-Tach®	N51502013
4 point Carriage	N51502429
Euro Carriage	N51502430
AL550	X
GCT 3-14	X
GCT 3-14 +	X
MLA 5-60 H-Z	X
ULM 412 H	X
ULM 412 H	X
ULM 415 H	X
ULM 415 H	X

VERPLICHTE UITRUSTING VAN MACHINES : 







## KLASSIEKE BALENKLEM



- Tandens 2x3 of 2x4.
- Gesynchroniseerde sluiting.
- Uitstekende hefcapaciteit van 1000 of 1200 kg aan 800 mm.
- Hanteert 1 ronde baal met een  $\varnothing$  van 1,8 m maximum voor 2x4 en  $\varnothing$  1,5 van 2 m voor 2x3.
- Hanteert 2 rechthoekige balen met een maximale hoogte van 0,8 m elk.
- Eenvoudig te gebruiken en efficiënt accessoire.
- Hanteert een ronde baal of tot 2 rechthoekige balen.
- Afgeronde smeedijzeren tanden die een nauwkeurige en schone penetratie in het materiaal bieden.
- Optioneel: bajonettandhouder 2 tanden (680 mm,  $\varnothing$  35) die een uitstekende stabiliteit garanderen tijdens het hanteren van rechthoekige balen.

	CLBR 2x3	PBG 2x4
Capaciteit (lb)	2645.55	3968.32
Gewicht (lb)	518.09	518.09
Totale hoogte (in)	4' 6"	4' 6"
Totale lengte (in)	3' 7"	3' 5"
Lengte vorken (in)	1' 1"	1' 1"
Breedte (in)	3' 7"	3' 7"
Lengte armen (in)	2' 4"	2'
Machine-apparatuur		
Tanden / Vingers	2 / 3	2 / 4
Opening minimum (in)	7"	4"
Opening maximum (in)	6' 5"	5' 10"
Minimum spreiding vorken (in)	1' 1"	1' 2"

Machine compatibiliteit		
Referentienummer	52001013	757612
ALT950	X	X
MLA-T 533-145 V+ - ST5	X	X
MLT 420-60 H	X	X
MLT 625-75 H	X	X
MLT 630-115	X	X
MLT 630-115 V	X	X
MLT 630-115 V CP	X	X
MLT 635-130 PS+	X	X
MLT 635-140 V+	X	X
MLT 730-115 V	X	X
MLT 730-115 V CP	X	X
MLT 733-115	X	X
MLT 733-115 LSU	X	X
MLT 737-130 PS+	X	X
MLT 741-130 PS+	X	X
MLT 741-140 V+	X	X
MLT 841-145 PS+	X	X
MLT 850-145 V+	X	X
MLT 940-140 V+	X	X
MLT 961-160 V+ L	X	X
MLT 1041-145 PS+L	X	X
MLT-X 625-75 H	X	X
MLT-X 732	X	X
MLT-X 735 T LSU	X	X
MLT-X 737-130 PS+	X	X
MLT-X 741-140 V+	X	X
MLT-X 741 T LSU	X	X
MLT-X 841 - 145 PS+	X	X
MLT-X 850-145 V+	X	X
MLT-X 961-160 V+ L	X	X
MLT-X 1041-145 PS+L	X	X

VERPLICHTE UITRUSTING VAN MACHINES : 



## MULTIFUNCTIONELE BALENKLEM

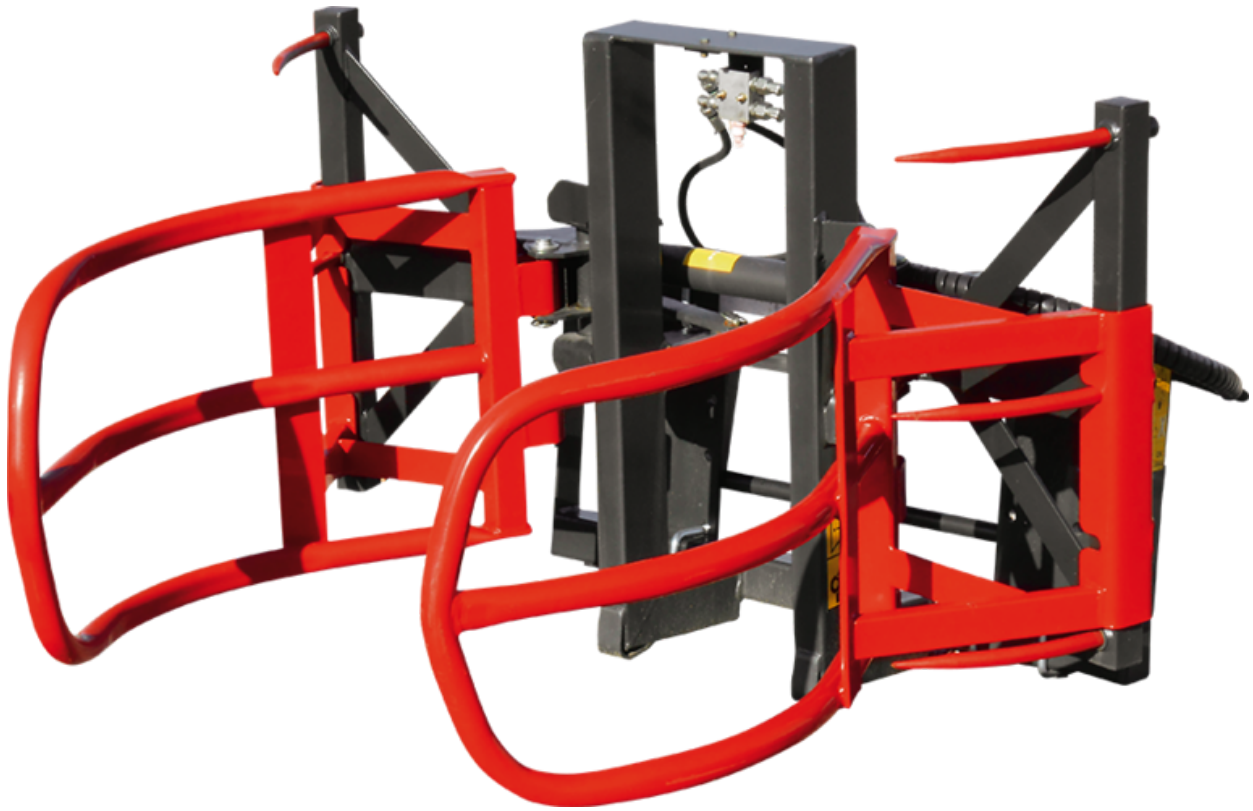

- 2 x 3 tanden.
- Gesynchroniseerde of niet-gesynchroniseerde sluitbeweging.
- Zeer goede hefcapaciteit van 800 kg.
- Om gewikkelde balen met een diameter van 1 m tot 1,60 m te verhandelen.
- Om gewikkelde balen met een diameter van 0,9 m tot 1,80 m te verhandelen.
- Om 2 rechthoekige balen met een hoogte van elk 1,2 m te verhandelen.
- Veelzijdig : een 2-in-1 accessoire : voor het manipuleren van zowel ronde balen, rechthoekige balen als ingepakte balen.
- Gemakkelijk in gebruik : van het ene accessoire naar het andere in minder dan 3 minuten.
- Geschikt voor 2 balen.
- Innoverend : gemakkelijk aan te haken zonder gereedschap of demontage.

	MBC 2x3
Capaciteit (lb)	1763.70
Gewicht (lb)	639.34
Totale hoogte (in)	3' 7"
Totale lengte (in)	4' 9"
Breedte over vorken (in)	1' 3"
Breedte (in)	3' 11"
Machine-apparatuur	
Tanden / Vingers	2 / 3
Opening minimum (in)	1' 5"
Opening maximum (in)	5' 2"

Machine compatibiliteit	
Referentienummer	790506
ALT950	X
MLA-T 533-145 V+ - ST5	X
MLT 625-75 H	X
MLT 630-115	X
MLT 630-115 V	X
MLT 630-115 V CP	X
MLT 635-130 PS+	X
MLT 635-140 V+	X
MLT 730-115 V	X
MLT 730-115 V CP	X
MLT 733-115	X
MLT 733-115 LSU	X
MLT 737-130 PS+	X
MLT 741-130 PS+	X
MLT 741-140 V+	X
MLT 841-145 PS+	X
MLT 940-140 V+	X
MLT 961-160 V+ L	X
MLT 1041-145 PS+L	X
MLT-X 625-75 H	X
MLT-X 732	X
MLT-X 735 T LSU	X
MLT-X 737-130 PS+	X
MLT-X 741-140 V+	X
MLT-X 741 T LSU	X
MLT-X 841 - 145 PS+	X
MLT-X 961-160 V+ L	X
MLT-X 1041-145 PS+L	X

VERPLICHTE UITRUSTING VAN MACHINES : 



## POTKLEM



- Scharnierende grijpers om de potten zachtjes vast te grijpen.
- Regelbare drukbegrenzer om de breekbare potten niet te beschadigen (terra cotta).
- Verhoogde bescherming van de componenten en vereenvoudigd onderhoud.
- Grijpers voor potten met een maximaal diameter van 1 m.
- Vergemakelijkt de verhandeling van potten en planten in pot.
- Vervangt doeltreffend vorken, gieken of mankracht.
- Brede opening en grote aanpassingscapaciteit voor verschillende vormen van potten.

CLP 1000 / 800	
Capaciteit (lb)	1763.70
Gewicht (lb)	299.83
Totale hoogte (in)	2' 3"
Totale lengte (in)	4' 1"
Breedte (in)	2' 6"
Diameter maximum (in)	3' 5"
Machine-apparatuur	
Opening minimum (in)	1' 4"
Opening maximum (in)	3' 3"

Machine compatibiliteit	
Referentienummer	914770
Referentievorkenbord schranklader	939690
MLT 420-60 H	X
MLT 625-75 H	X
MLT-X 625-75 H	X
MT 420 H	X
MT 625 e	X
MT 625 HA	X
MT-X 625 H	X

**VERPLICHTE UITRUSTING VAN MACHINES :** 



## POTTENKLEM (COMPACTE MACHINES)

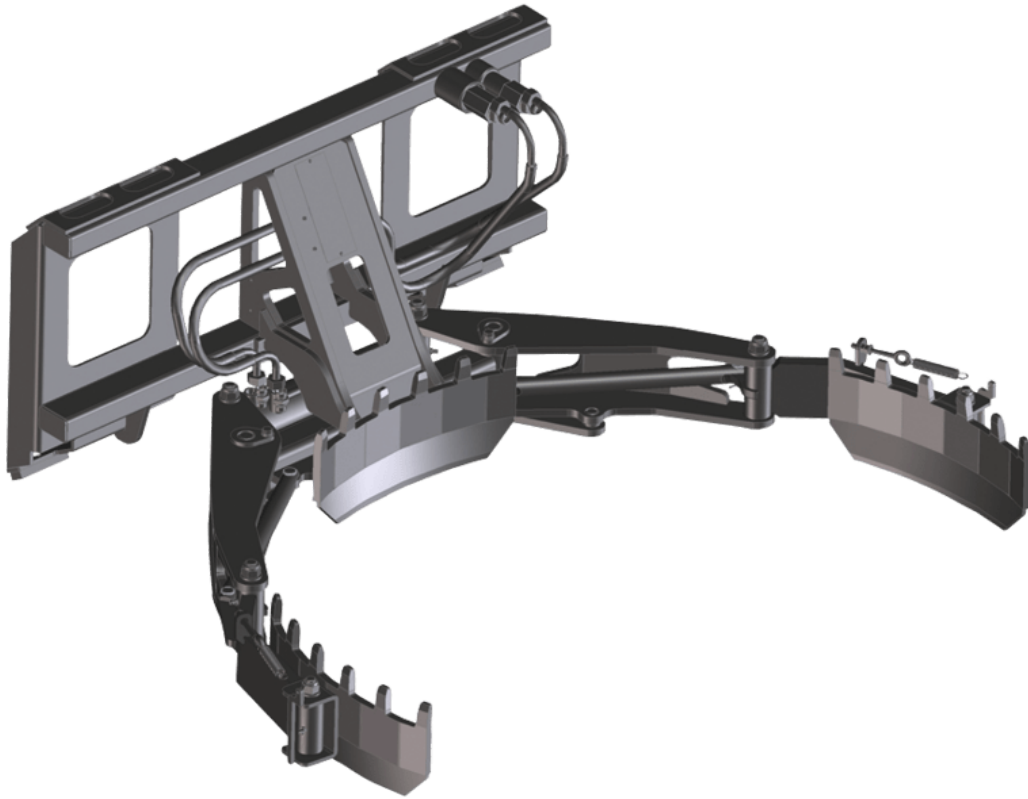

- Scharnierende grijpers om de potten zachtjes vast te grijpen.
- Regelbare drukbegrenzer om de breekbare potten niet te beschadigen (terra cotta).
- Vergemakelijkt de verhandeling van potten en planten in pot.
- Vervangt doeltreffend vorken, gieken of mankracht.



	CLP 1000 / 800
Capaciteit (lb)	1763.70
Gewicht (lb)	240.30
Totale hoogte (in)	1' 8"
Totale lengte (in)	3' 8"
Breedte (in)	2' 3"
Diameter minimum / Diameter maximum (in)	1' 4" / 3' 5"
Machine-apparatuur	
Opening minimum (in)	1' 4"
Opening maximum (in)	3' 3"

Machine compatibiliteit	
All-Tach® Narrow	N51502717
All-Tach®	N51502716
4 point Carriage	52742066
Euro Carriage	52742067
AL650	X
AL750	X
GCT 3-14	X
GCT 3-14 +	X
MLA 6-65 H-Z	X
MLA 7-75 H-Z	X
ULM 412 H	X
ULM 412 H	X
ULM 415 H	X
ULM 415 H	X

VERPLICHTE UITRUSTING VAN MACHINES : 





## RONDE BALENKLEM (COMPACTE MACHINES)

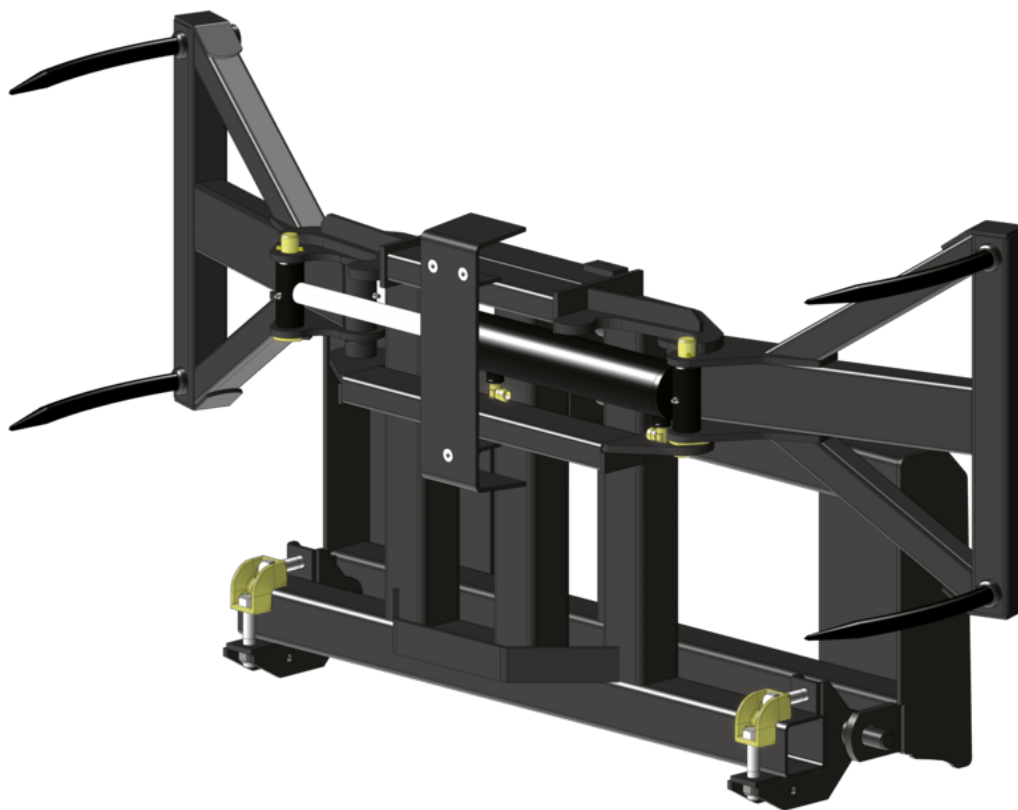

- Kan worden gebruikt voor rechthoekige balen.
- Gesynchroniseerde armen met elk 4 gesmede tanden.
- Werktuig ontworpen om ronde balen te verhandelen.
- Laat een eenvoudige en prope verhandeling toe.



	CLBR 2x2 / 800
Capaciteit (lb)	1763.70
Gewicht (lb)	330.69
Totale hoogte (in)	2' 10"
Totale lengte (in)	3'
Breedte (in)	3' 7"
Machine-apparatuur	
Tanden / Vingers	2 / 2
Opening minimum (in)	2' 7"
Opening maximum (in)	5' 2"
Minimum spreiding vorken (in)	6"

Machine compatibiliteit	
All-Tach® Narrow	N51502696
All-Tach®	N51502631
4 point Carriage	N51502632
Euro Carriage	N51502633
AL550	X
AL650	X
AL750	X
GCT 3-14	X
GCT 3-14 +	X
MLA 5-60 H-Z	X
MLA 6-65 H-Z	X
MLA 7-75 H-Z	X
ULM 412 H	X
ULM 412 H	X
ULM 415 H	X
ULM 415 H	X

VERPLICHTE UITRUSTING VAN MACHINES : 



## SUPER COMPACTE BALENKLEM

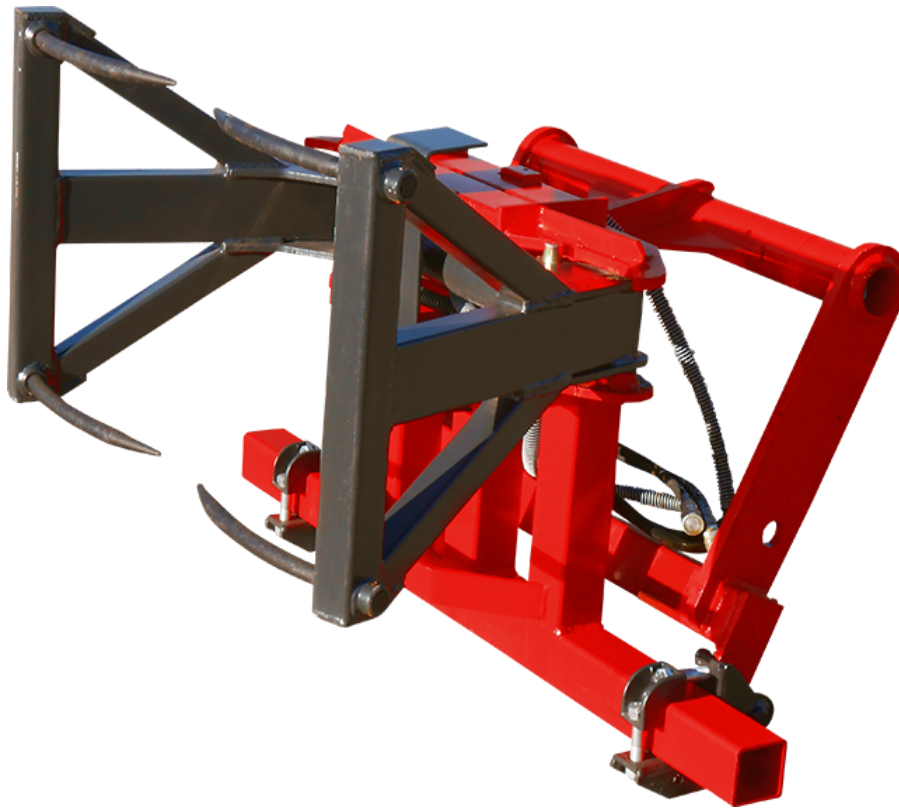

- 2x2 tanden.
- Niet-gesynchroniseerde sluitbeweging.
- Capaciteit : 800 kg.
- Om 1 ronde baal te verhandelen - Ø 1,8 m maximum.
- Om 1 rechthoekige baal te verhandelen - 1,2 m hoogte.
- Gemakkelijk te gebruiken en duurzaam accessoire.
- Zeer compacte klem.
- Ideaal voor het stapelen onder een dak.
- Afgeronde, gesmede ijzeren tanden zorgen ervoor dat u precies en proper in de materie kan doordringen.



	PBG 2x2
Capaciteit (lb)	1763.70
Gewicht (lb)	343.92
Totale hoogte (in)	2' 10"
Totale lengte (in)	3'
Lengte vorken (in)	1' 1"
Breedte (in)	3' 7"
Lengte armen (in)	1' 8"
Machine-apparatuur	
Tanden / Vingers	2 / 2
Opening maximum (in)	5' 2"

Machine compatibiliteit	
Referentienummer	757639
MLT 420-60 H	X
MLT 625-75 H	X
MLT 630-115	X
MLT 630-115 V	X
MLT 630-115 V CP	X
MLT 635-130 PS+	X
MLT 635-140 V+	X
MLT 730-115 V	X
MLT 730-115 V CP	X
MLT 733-115	X
MLT 733-115 LSU	X
MLT 737-130 PS+	X
MLT 741-130 PS+	X
MLT 741-140 V+	X
MLT 841-145 PS+	X
MLT 940-140 V+	X
MLT 1041-145 PS+L	X
MLT-X 625-75 H	X
MLT-X 735 T LSU	X
MLT-X 737-130 PS+	X
MLT-X 741-140 V+	X
MLT-X 741 T LSU	X
MLT-X 841 - 145 PS+	X
MLT-X 1041-145 PS+L	X

**VERPLICHTE UITRUSTING VAN MACHINES :** 



## VIERKANTE BALENKLEM



- Capaciteit : 2100 kg / 5 balen (hoogte: 700 mm).
- Versterkte onderstel en grijper voor de meest veeleisende werven.
- 2 x 7 gesmeede tanden, Ø 25 mm lengte 340 mm.
- 3 x bajonettanden, Ø 40 mm lengte 1000 mm.
- Gesynchroniseerde sluiting.

- Kracht en grote capaciteit voor intensief stro stapelen.
- Zijdelings scharnieren van de armen : mogelijk om onder een dak te werken.
- Goede penetratie en heel goede grip. Mogelijk om één baal te klemmen en te draaien.



	CLBS 2x7 / 2100
Capaciteit (lb)	4629.71
Gewicht (lb)	1675.51
Totale hoogte (in)	9' 11"
Totale lengte (in)	5' 3"
Lengte vorken (in)	3' 3"
Breedte (in)	5' 11"
Machine-apparatuur	
Tanden / Vingers	14 / 3
Opening minimum (in)	1' 5"
Opening maximum (in)	5' 2"
3 Ronde baal maximale diameter (in)	5' 11"
3 Vierkante baal maximale hoogte (in)	3' 11"

Machine compatibiliteit	
Referentienummer	52000015
MLT 841-145 PS+	X
MLT 850-145 V+	X
MLT 940-140 V+	X
MLT 961-160 V+ L	X
MLT 1041-145 PS+L	X
MLT-X 841 - 145 PS+	X
MLT-X 850-145 V+	X
MLT-X 961-160 V+ L	X
MLT-X 1041-145 PS+L	X

**VERPLICHTE UITRUSTING VAN MACHINES :** 



## VIERKANTE BALENKLEM (COMPACTE MACHINES)

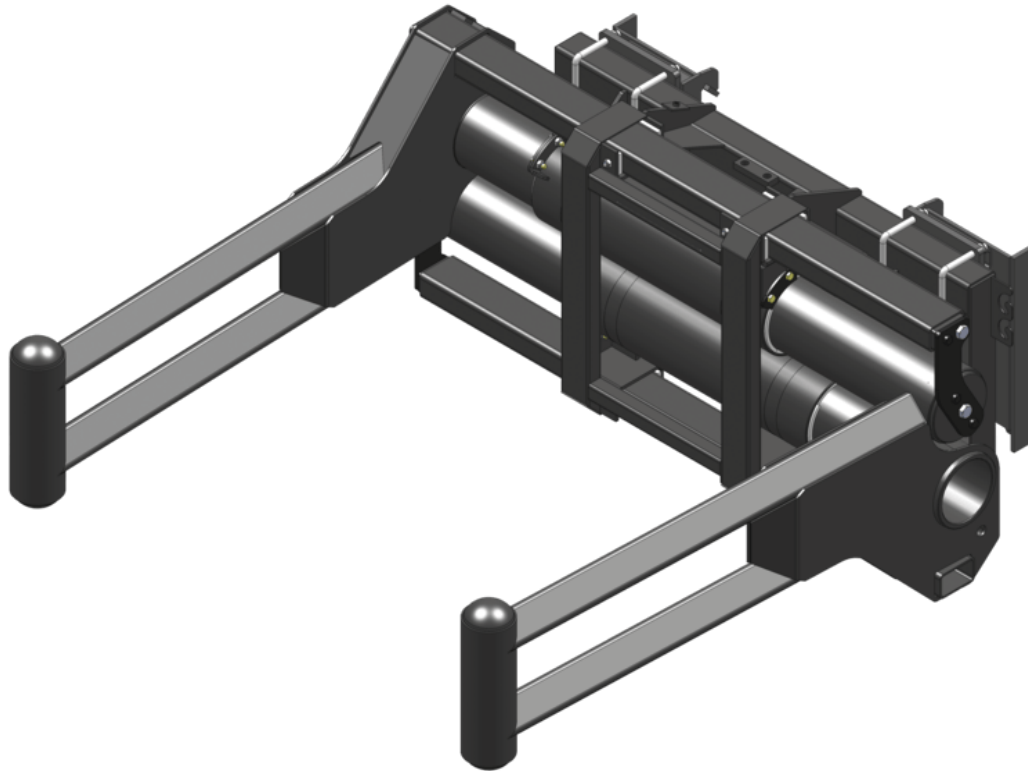

- Robuuste kader en componenten voor intensieve toepassingen.
- Telescoop kinematic - zachte bewegingen en sterke knijpcapaciteit.
- Algemeen gebruik van téflon®.
- Beperkt onderhoud.
- Standaard drukbegrenzer.
- Buisvormige structuur - geen enkel risico op schade aan de folie bij de verplaatsing van gewikkelde balen.
- Grote opening van de klem om grote balen of verschillende gangbare balen te verhandelen.
- Hogere bescherming van de componenten.
- Multi inzetbaar: ontworpen voor rechthoekige gewikkelde balen, kan ook worden gebruikt voor standaard rechthoekige balen of ronde balen.

	CLBSW 2000 / 1000
Capaciteit (lb)	2204.62
Gewicht (lb)	1051.60
Totale hoogte (in)	2' 3"
Lengte armen (in)	5' 11"
Machine-apparatuur	
Opening minimum (in)	2' 5"
Opening maximum (in)	6' 10"

Machine compatibiliteit	
All-Tach®	N51502694
4 point Carriage	N51502693
Euro Carriage	N51502692
AL650	X
AL750	X
MLA 6-65 H-Z	X
MLA 7-75 H-Z	X





# VORKDRAGERS

## Bereik

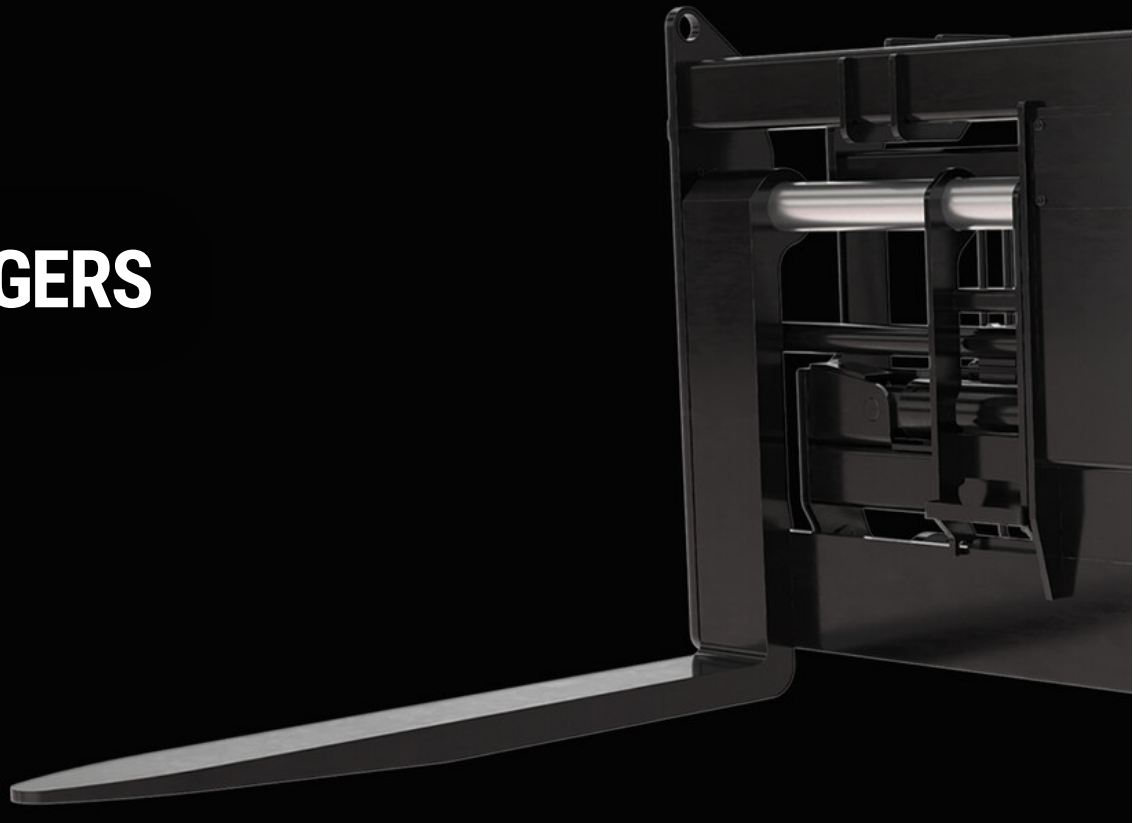

91 Palletvorken compleet (compacte machines)

94 Rijtuig Drijvende Laadsteun En Vorken (MHT)

**NEW**

97 Rijtuig Drijvende Laadsteun En Vorken (MRT)

**NEW**

99 Rijtuig Drijvende Laadsteun En Vorken (MT - MLT)

**NEW**

103 Vast vorkenbord

108 Vast vorkenbord (MRT - MHT)

**NEW**

111 Vast vorkenbord met sideshift (MLT - MT)

114 Vast vorkenbord met sideshift (MRT - MHT)

**NEW**

116 Verstelbare vorkschort met load backplash (MLT - MT)

119 Vlottend vorkenbord (MLT - MT)

122 Vlottend vorkenbord met hydraulische schuinstelling

124 Vlottend vorkenbord met sideshift (MLT - MT)

**NEW**

127 Vlottend vorkenbord met sideshift (MRT)

**NEW**

129 Zijdelingse kantelbare vorkdeur - Load backplash (MLT - MT)



## PALLETVORKEN COMPLEET (COMPACTE MACHINES)



- Breed onderstel met achterbord voor meer stabiliteit tijdens verplaatsingen.
- Gestandaardiseerde FEM vorken met zijdelingse verstelling.
- Een all-round werktuig om paletten te verhandelen.

	CAT 915 / 800	CAT 920 / 1000	CAT 920 / 1100	CAT 920 / 1200	CAT 1200 / 1200
Capaciteit (lb)	1763.70	2204.62	2425.08	2645.55	2645.55
Gewicht (lb)	253.53	-	-	-	352.74
Totale hoogte (in)	2' 11"	2' 11"	2' 11"	2' 11"	2' 11"
Vorkgedeelte X Lengte vorken (in)	1" X 2' 7"	3' 3"	3' 7"	3' 11"	3' 11"
Breedte (in)	3'	3'	3'	3'	4'
Diepte (in)	4' 2"	3' 10"	4' 2"	4' 6"	4' 11"
Machine-apparatuur	×	×	×	×	×

Machine compatibiliteit					
All-Tach® Narrow	-	52807868	52807867	52799512	-
All-Tach®	-	N004019	-	-	-
4 point Carriage	-	52813313	52796388	52799521	-
Euro Carriage	-	52807866	52799511	-	-
850 R	X	-	-	-	-
AL420	-	X	X	X	-
AL430	-	X	X	X	-
AL650	-	-	-	-	X
AL750	-	-	-	-	X
MLA 2-25 H	-	X	-	-	-
MLA 3-25 H	-	X	-	-	-
MLA 3-25 H-C	-	X	-	-	-
MLA 4-50 H	-	-	X	X	-
MLA 4-50 H-C	-	-	X	X	-
MLA 6-65 H-Z	-	-	-	-	X
MLA 7-75 H-Z	-	-	-	-	X

	CAT 1210 / 1200 (b)	CAT 1220 / 1000 (a)	CAT 1220 / 1100 (a)	CAT 1220 / 1200 (a)
Capaciteit (lb)	2645.55	2204.62	2425.08	2645.55
Gewicht (lb)	403.45	335.10	352.74	363.76
Totale hoogte (in)	2' 11"	2' 11"	2' 11"	2' 11"
Vorkgedeelte X Lengte vorken (in)	3' 11"	3' 3"	3' 7"	3' 11"
Breedte (in)	4'	4'	4'	4'
Diepte (in)	4' 5"	4' 4"	4' 4"	4' 4"
Machine-apparatuur	×	×	×	×

Machine compatibiliteit				
All-Tach® Narrow	-	-	-	-
All-Tach®	52799516	-	-	-
4 point Carriage	52799513	-	-	-
Euro Carriage	52799514	-	-	-
1050 R	-	X	-	-
1050 RT	-	X	-	-
1350 R NXT2	-	X	-	-
1650 R	-	-	X	X
1650 RT	-	-	X	X
2700 V NXT:2	-	-	X	X
3300 V NXT:2	-	-	X	X
4200 V	-	-	X	X



NEW

## RIJTUIG DRIJVENDE LAADSTEUN EN VORKEN (MHT)



- Lastrugleuning standaard.
- Vorkenverstelling.
- Vorkenvergrendeling mogelijk - bestel kit ref. 52675100.
- Opmerking: Verplichte verkeerskit in Italië. Neem contact op met uw dealer.
- Oplossing aangepast aan oneffen ondergrond : zwevende vorken + nivellering.

	CAF 1750 / 15 T	CAF 1750 / 16 T	CAF 1750 / 20 T	CAF 1750 / 12.5 T	CAF 2000 / 22 T	CAF 2000 / 25 T	CAF 2500 / 15 T
Capaciteit (lb)	33069.34	35273.96	44092.45	27557.78	48501.70	55115.57	33069.34
Totale hoogte (in)	5' 3"	5'	5' 3"	5'	5' 4"	5' 4"	5' 3"
Breedte (in)	5' 9"	6' 3"	5' 9"	6' 3"	7'	7'	8' 2"
Machine-apparatuur	×	×	×	×	×	×	×
Minimum spreiding vorken (in)	1' 6"	1' 8"	1' 6"	1' 10"	3' 8"	3' 5"	3' 4"
Maximum spreiding vorken (in)	5' 3"	5' 9"	5' 3"	5' 9"	6' 6"	6' 6"	7' 9"

## Beschikbare vorkafmetingen

180 x 75 x 1200		52699113					
200 x 80 x 1200			52694204				
180 x 75 x 1500		52699114					
180 x 75 x 1800		52699115					
200 x 80 x 1800			52694205				
220 x 100 x 1800						52694547	
200 x 85 x 2400				52699116			
200 x 95 x 2400	52694206						52694209
250 x 100 x 2400					52694548		
200 x 95 x 3000							52694210

## Machine compatibiliteit

MHT 10135 ST5	-	X	-	X	-	-	-
MHT 10160 ST5	-	X	-	X	-	-	-
MHT 10200 ST5	X	-	X	-	-	-	X
MHT 11250 ST5	-	-	-	-	X	X	-
MHT-X 10135 ST3A	-	X	-	X	-	-	-
MHT-X 10160 ST3A	-	X	-	X	-	-	-
MHT-X 10200 ST3A	X	-	X	-	-	-	X
MHT-X 11250 ST3A	-	-	-	-	X	X	-

**VERPLICHTE UITRUSTING VAN MACHINES :** ×

	CAF 2500 / 16 T	CAF 2500 / 20 T	CAF 2500 / 22 T	CAF 2500 / 25 T	CAF 2500 / 12.5 T	TFF 9 T (a)	TFF 9 T (b)
Capaciteit (lb)	35273.96	44092.45	48501.70	55115.57	27557.78	19841.60	19841.60
Totale hoogte (in)	5'	5'	5' 4"	5' 4"	5'	4' 7"	3' 3"
Breedte (in)	8' 2"	8' 2"	8' 4"	8' 4"	8' 2"	5' 2"	7'
Machine-apparatuur	×	×	×	×	×	×	×
Minimum spreiding vorken (in)	3' 2"	3' 4"	3' 8"	3' 5"	3' 4"	1' 9"	1' 10"
Maximum spreiding vorken (in)	7' 9"	7' 9"	7' 9"	7' 9"	7' 9"	4' 8"	6' 7"

## Beschikbare vorkafmetingen

200 x 60 x 1200						939800	939347
180 x 75 x 1200	52700264						
200 x 80 x 1200		52694207					
200 x 60 x 1500						939345	939348
180 x 75 x 1500	52700265						
180 x 75 x 1800	52700266						
200 x 80 x 1800		52694208					
220 x 100 x 1800				52694549			
200 x 60 x 2000						939346	939349
200 x 85 x 2400					52700267		
250 x 100 x 2400			52694550				
250 x 100 x 3000			52694551				

## Machine compatibiliteit

MHT 790 ST5	-	-	-	-	-	X	X
MHT 10135 ST5	X	-	-	-	X	-	-
MHT 10160 ST5	X	-	-	-	X	-	-
MHT 10200 ST5	-	X	-	-	-	-	-
MHT 11250 ST5	-	-	X	X	-	-	-
MHT-X 790 ST3A	-	-	-	-	-	X	X
MHT-X 10135 ST3A	X	-	-	-	X	-	-
MHT-X 10160 ST3A	X	-	-	-	X	-	-
MHT-X 10200 ST3A	-	X	-	-	-	-	-
MHT-X 11250 ST3A	-	-	X	X	-	-	-

**VERPLICHTE UITRUSTING VAN MACHINES :** ×





NEW

## RIJTUIG DRIJVENDE LAADSTEUN EN VORKEN (MRT)



- Lastrugleuning standaard.
- Vorkenverstelling.
- Vorkenvergrendeling mogelijk - bestel kit ref. 52675100.
- Opmerking: Verplichte verkeerskit in Italië. Neem contact op met uw dealer.
- Opmerking: de verkeersset is in Duitsland verplicht op MRTs Vision/Vision+. Neem contact op met uw dealer.
- Oplossing aangepast aan oneffen ondergrond : zwevende vorken + nivellering.

	CAF 1030 / 6 T	CAF 1030 / 7 T	CAF 1030 / 4.5 T	CAF 1800 / 7 T	TFF 4.5 T
Capaciteit (lb)	13227.74	15432.36	9920.80	15432.36	9920.80
Totale hoogte (in)	3' 4"	3' 5"	4' 2"	3' 6"	4' 2"
Breedte (in)	3' 8"	3' 8"	3' 8"	6' 3"	3' 8"
Machine-apparatuur	×	×	×	×	×
Minimum spreiding vorken (in)	1' 8"	2'	8"	2'	10"
Maximum spreiding vorken (in)	3' 4"	3' 4"	3' 5"	5' 11"	3' 5"

## Beschikbare vorkafmetingen

125 x 50 x 1200					924857
100 x 60 x 1200	52658467		52721040		
125 x 60 x 1200		52676010		52701150	
100 x 60 x 1500	52719487				
125 x 60 x 1500		52719444		52719494	
100 x 60 x 1800	52719488				
125 x 60 x 1800		52719446		52719495	

## Machine compatibiliteit

MRT 1645 75	-	-	X	-	X
MRT 1645 115	-	-	X	-	X
MRT 1845 75	-	-	X	-	X
MRT 1845 115	-	-	X	-	X
MRT 2145 115	-	-	X	-	X
MRT 2260	X	-	-	X	-
MRT 2260 e	X	-	-	X	-
MRT 2545 115	-	-	X	-	X
MRT 2570	-	X	-	X	-
MRT 2660	X	-	-	X	-
MRT 2660 e	X	-	-	X	-
MRT 3060	X	-	-	X	-
MRT 3570	-	X	-	X	-
MRT 3570 ES	-	X	-	X	-
MRT-X 1645	-	-	X	-	X
MRT-X 1845	-	-	X	-	X
MRT-X 2145	-	-	X	-	X
MRT-X 2260	X	-	-	X	-
MRT-X 2545	-	-	X	-	X
MRT-X 2570	-	X	-	X	-
MRT-X 2660	X	-	-	X	-
MRT-X 3060	X	-	-	X	-
MRT-X 3570	-	X	-	X	-
MRT-X 3570 ES	-	X	-	X	-

**VERPLICHTE UITRUSTING VAN MACHINES :** ×



NEW

## RIJTUIG DRIJVENDE LAADSTEUN EN VORKEN (MT - MLT)



- Lastrugleuning standaard.
- Vorkenverstelling.
- Vorkenvergrendeling mogelijk - bestel kit ref. 52675100.
- Opmerking: Verplichte verkeerskit in Italië. Neem contact op met uw dealer.
- Oplossing aangepast aan oneffen ondergrond : zwevende vorken + nivellering.

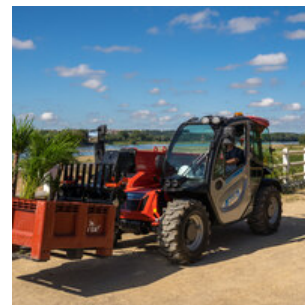

	CAF 1000 / 3 LB	CAF 1000 / 3 LB (b)	CAF 1000 / 1.5 LB	CAF 1000 / 4.1 LB
Capaciteit (lb)	6613.87	6613.87	3306.93	9038.95
Gewicht (lb)	529.11	559.97	385.81	674.61
Totale hoogte (in)	3' 3"	3' 3"	3' 5"	3' 5"
Totale lengte (in)	4' 6"	4' 10"	4' 6"	5'
Breedte (in)	3' 3"	3' 3"	3' 10"	3' 10"
Machine-apparatuur	×	×	×	×
Minimum spreiding vorken (in)	10"	11"	6"	1' 7"
Maximum spreiding vorken (in)	3'	3'	3'	3' 4"

## Beschikbare vorkafmetingen

100 x 50 x 1070	315452			
75 x 35 x 1100			52693600	
120 x 40 x 1200		52744200		
100 x 50 x 1200				52722290

## Machine compatibiliteit

Referentienummer	52654990	52744200	-	-
All-Tach®	-	-	52693600	-
4 point Carriage	-	-	52723634	-
Euro Carriage	-	-	52723635	-
GCT 3-14	-	-	X	-
GCT 3-14 +	-	-	X	-
MLT 420-60 H	X	X	-	-
MLT 625-75 H	X	X	-	-
MLT 733-115	-	-	-	X
MLT 733-115 LSU	-	-	-	X
MLT 737-130 PS+	-	-	-	X
MLT 741-130 PS+	-	-	-	X
MLT 741-140 V+	-	-	-	X
MLT 841-145 PS+	-	-	-	X
MLT 940-140 V+	-	-	-	X
MLT 1041-145 PS+L	-	-	-	X
MLT-X 625-75 H	X	X	-	-
MLT-X 732	-	-	-	X
MLT-X 735 T LSU	-	-	-	X
MLT-X 735 T LSU (70 KW)	-	-	-	X
MLT-X 737-130 PS+	-	-	-	X
MLT-X 741-140 V+	-	-	-	X
MLT-X 841 - 145 PS+	-	-	-	X
MLT-X 1035 LT LSU	-	-	-	X
MLT-X 1041-145 PS+L	-	-	-	X
MT 420 H	X	X	-	-
MT 625 e	X	X	-	-
MT 625 HA	X	X	-	-
MT 730 H	X	X	-	-
MT 735 75D ST5	-	-	-	X

	CAF 1000 / 3 LB	CAF 1000 / 3 LB (b)	CAF 1000 / 1.5 LB	CAF 1000 / 4.1 LB
<b>Machine compatibiliteit</b>				
MT 930 H	X	X	-	-
MT 930 HA	X	X	-	-
MT 933 Easy	-	-	-	X
MT 935 75D ST5	-	-	-	X
MT 1033 easy	-	-	-	X
MT 1135 75 D	-	-	-	X
MT 1135 H 100D	-	-	-	X
MT 1135 easy ST5	-	-	-	X
MT 1135 H easy ST5	-	-	-	X
MT 1135 HA Easy ST5	-	-	-	X
MT 1135 ST5	-	-	-	X
MT 1335 75D ST5	-	-	-	X
MT 1335 100D ST5	-	-	-	X
MT 1335	-	-	-	X
MT 1335 easy ST5	-	-	-	X
MT 1335 H 75D ST5	-	-	-	X
MT 1335 H 100D ST5	-	-	-	X
MT 1335 H easy ST5	-	-	-	X
MT 1335 HA 75D ST5	-	-	-	X
MT 1335 HA 100D ST5	-	-	-	X
MT 1335 HA easy ST5	-	-	-	X
MT 1335 ST5	-	-	-	X
MT 1440 A	-	-	-	X
MT 1440 A ST5	-	-	-	X
MT 1440 easy ST5	-	-	-	X
MT 1440 HA	-	-	-	X
MT 1440 HA ST5	-	-	-	X
MT 1440 ST5	-	-	-	X
MT 1840 A 100D ST5 S1	-	-	-	X
MT 1840 A	-	-	-	X
MT 1840 easy ST5	-	-	-	X
MT 1840 HA	-	-	-	X
MT 1840 HA	-	-	-	X
MT 1840 ST5	-	-	-	X
MT-X 420 H	X	X	-	-
MT-X 625 H	X	X	-	-
MT-X 1033	-	-	-	X
MT-X 1440	-	-	-	X
MT-X 1440 A	-	-	-	X
MT-X 1840	-	-	-	X
MT-X 1840 A	-	-	-	X
ULM 412 H	-	-	X	-
ULM 412 H	-	-	X	-
ULM 415 H	-	-	X	-

CAF 1000 / 3 LB

CAF 1000 / 3 LB (b)

CAF 1000 / 1.5 LB

CAF 1000 / 4.1 LB

## Machine compatibiliteit

ULM 415 H	-	-	X	-
-----------	---	---	---	---

VERPLICHTE UITRUSTING VAN MACHINES : ✕



## VAST VORKENBORD



- Pendelende vorken.
- Vorken conform aan de FEM/ISO norm, lengte van de vorken afhankelijk van het model.
- De vorken zijn niet inbegrepen in de PFB, gelieve 2 vorken te bestellen (behalve voor CAT 1260/5T + F 150x50x1200).
- Een eenvoudige en efficiënte oplossing om goederen te vervoeren in ruw terrein

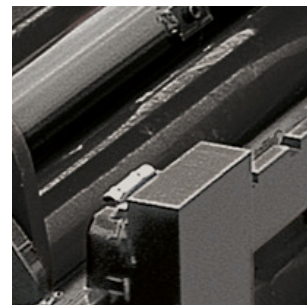

	CAT 1020 / 1.5 LB + 2 F 75x35x1100	CAT 1260 / 5 T + F 150x50x1200	PFB 20N 1020	PFB 25N 1020	PFB 25N 1260	PFB 35N 1260	PFB 35N 1470
Capaciteit (lb)	3306.93	11023.11	4409.25	5511.56	5511.56	7716.18	7716.18
Gewicht (lb)	302.03	895.08	365.97	156.53	176.37	205.03	257.94
Totale hoogte (in)	2' 3"	2' 3"	1' 11"	-	-	-	-
Totale lengte (in)	4' 6"	4' 11"	-	-	-	-	-
Breedte (in)	3' 5"	4' 3"	3' 5"	3' 4"	4' 3"	4' 3"	5'
Machine-apparatuur	×	×	×	×	×	×	×
Minimum spreiding vorken (in)	8"	1'	9"	-	-	-	-
Maximum spreiding vorken (in)	3' 2"	3' 9"	3' 3"	-	-	-	-

## Beschikbare vorkafmetingen

75 x 35 x 1100	52724830						
100 x 40 x 1200			415691				
125 x 45 x 1200				415835		415618	
150 x 50 x 1200		578097					

## Machine compatibiliteit

Referentienummer	-	52735505	52558727	571958	571959	653744	653745
Referentievorkenbord schranklader	-	-	52000825	-	-	-	-
All-Tach®	52706271	-	-	-	-	-	-
4 point Carriage	52723636	-	-	-	-	-	-
Euro Carriage	52723637	-	-	-	-	-	-
ALT950	-	-	-	-	-	X	-
GCT 3-14	X	-	-	-	-	-	-
GCT 3-14 +	X	-	-	-	-	-	-
MLA-T 533-145 V+ - ST5	-	-	-	-	-	X	-
MLT 420-60 H	-	-	X	-	-	-	-
MLT 625-75 H	-	-	-	X	X	-	-
MLT 630-115	-	-	-	-	-	-	X
MLT 630-115 V	-	-	-	-	-	X	X
MLT 630-115 V CP	-	-	-	-	-	X	X
MLT 635-130 PS+	-	-	-	-	-	X	X
MLT 635-140 V+	-	-	-	-	-	X	X
MLT 730-115 V	-	-	-	-	-	X	X
MLT 730-115 V CP	-	-	-	-	-	X	X
MLT 733-115	-	-	-	-	-	X	X
MLT 733-115 LSU	-	-	-	-	-	X	X
MLT 850-145 V+	-	X	-	-	-	-	-
MLT-X 625-75 H	-	-	-	X	X	-	-
MLT-X 732	-	-	-	-	-	X	-
MLT-X 735 T LSU	-	-	-	-	-	X	X
MLT-X 850-145 V+	-	X	-	-	-	-	-
MLT-X 1035 LT LSU	-	-	-	-	-	X	X
MT 420 H	-	-	X	-	-	-	-
MT 625 e	-	-	-	X	X	-	-
MT 625 HA	-	-	-	X	X	-	-
MT 733 Easy	-	-	-	-	-	X	X



CAT 1020 / 1.5 LB + 2 F 75x35x1100	CAT 1260 / 5 T + F 150x50x1200	PFB 20N 1020	PFB 25N 1020	PFB 25N 1260	PFB 35N 1260	PFB 35N 1470
---------------------------------------	-----------------------------------	-----------------	-----------------	-----------------	-----------------	-----------------

Machine compatibiliteit						
MT 735 75D ST5	-	-	-	-	X	X
MT 933 Easy	-	-	-	-	X	X
MT 935 75D ST5	-	-	-	-	X	X
MT 1033 easy	-	-	-	-	X	X
MT 1135 75 D	-	-	-	-	X	X
MT 1135 H 100D	-	-	-	-	X	X
MT 1335 75D ST5	-	-	-	-	X	X
MT 1335 100D ST5	-	-	-	-	X	X
MT 1335	-	-	-	-	X	X
MT 1335 H 75D ST5	-	-	-	-	X	X
MT 1335 H 100D ST5	-	-	-	-	X	X
MT 1335 HA 75D ST5	-	-	-	-	X	X
MT 1335 HA 100D ST5	-	-	-	-	X	X
MT-X 420 H	-	-	X	-	-	-
MT-X 625 H	-	-	-	X	X	-
MT-X 733 Mining	-	-	-	-	X	X
MT-X 1033 Mining	-	-	-	-	X	X
MT-X 1033 A Mining	-	-	-	-	X	X
ULM 412 H	X	-	-	-	-	-
ULM 412 H	X	-	-	-	-	-
ULM 415 H	X	-	-	-	-	-
ULM 415 H	X	-	-	-	-	-

VERPLICHTE UITRUSTING VAN MACHINES : ✕

	PFB 35N 1580	PFB 45N 1260	PFB 45N 1670	PFB 45N 2000	PFB 75MT 1750	PFB 75MT 2000	PFB FEM4 1200
Capaciteit (lb)	7716.18	9920.80	9920.80	9920.80	16534.67	16534.67	13227.74
Gewicht (lb)	268.96	436.52	555.56	650.36	-	-	-
Totale hoogte (in)	-	-	-	-	-	-	-
Totale lengte (in)	-	-	-	-	-	-	-
Breedte (in)	5' 4"	4' 3"	5' 7"	6' 8"	6'	6' 10"	3' 11"
Machine-apparaat	×	×	×	×	×	×	×
Minimum spreiding vorken (in)	-	-	-	-	-	-	-
Maximum spreiding vorken (in)	-	-	-	-	-	-	-

## Beschikbare vorkafmetingen

125 x 50 x 1200		415652		615652			
200 x 60 x 1200							513110

## Machine compatibiliteit

Referentienummer	653746	654407	653747	653748	504107	527216	732330
Referentievorkenbord schranklader	-	-	-	-	-	-	-
All-Tach®	-	-	-	-	-	-	-
4 point Carriage	-	-	-	-	-	-	-
Euro Carriage	-	-	-	-	-	-	-
MLT 630-115	X	-	-	-	-	-	-
MLT 630-115 V	X	-	-	-	-	-	-
MLT 630-115 V CP	X	-	-	-	-	-	-
MLT 635-130 PS+	X	-	-	-	-	-	-
MLT 635-140 V+	X	-	-	-	-	-	-
MLT 730-115 V	X	-	-	-	-	-	-
MLT 730-115 V CP	X	-	-	-	-	-	-
MLT 733-115	X	-	-	-	-	-	-
MLT 733-115 LSU	X	-	-	-	-	-	-
MLT 737-130 PS+	-	-	X	X	-	-	-
MLT 741-130 PS+	-	X	X	X	-	-	-
MLT 741-140 V+	-	X	X	X	-	-	-
MLT 841-145 PS+	-	X	X	-	-	-	-
MLT 940-140 V+	-	-	X	X	-	-	-
MLT 961-160 V+ L	-	-	-	-	X	X	X
MLT 1041-145 PS+L	-	X	X	-	-	-	-
MLT-X 735 T LSU	X	-	-	-	-	-	-
MLT-X 737-130 PS+	-	-	X	X	-	-	-
MLT-X 741-140 V+	-	X	X	X	-	-	-
MLT-X 741 T LSU	-	X	X	-	-	-	-
MLT-X 841 - 145 PS+	-	X	X	-	-	-	-
MLT-X 961-160 V+ L	-	-	-	-	X	X	X
MLT-X 1035 LT LSU	X	-	-	-	-	-	-
MLT-X 1041-145 PS+L	-	X	X	-	-	-	-
MT 733 Easy	X	-	-	-	-	-	-
MT 735 75D ST5	X	-	-	-	-	-	-
MT 933 Easy	X	-	-	-	-	-	-

PFB 35N 1580 PFB 45N 1260 PFB 45N 1670 PFB 45N 2000 PFB 75MT 1750 PFB 75MT 2000 PFB FEM4 1200

Machine compatibiliteit							
MT 935 75D ST5	X	-	-	-	-	-	-
MT 1033 easy	X	-	-	-	-	-	-
MT 1135 75 D	X	-	-	-	-	-	-
MT 1135 H 100D	X	-	-	-	-	-	-
MT 1335 75D ST5	X	-	-	-	-	-	-
MT 1335 100D ST5	X	-	-	-	-	-	-
MT 1335 H 75D ST5	X	-	-	-	-	-	-
MT 1335 H 100D ST5	X	-	-	-	-	-	-
MT 1335 HA 75D ST5	X	-	-	-	-	-	-
MT 1335 HA 100D ST5	X	-	-	-	-	-	-
MT 1440 A ST5	-	X	-	X	-	-	-
MT 1440 easy ST5	-	X	-	X	-	-	-
MT 1440 HA ST5	-	X	-	X	-	-	-
MT 1440 ST5	-	X	-	X	-	-	-
MT 1840 A 100D ST5 S1	-	X	-	X	-	-	-
MT 1840 easy ST5	-	X	-	X	-	-	-
MT 1840 HA	-	X	-	X	-	-	-
MT 1840 ST5	-	X	-	X	-	-	-
MT-X 733 Mining	X	-	-	-	-	-	-
MT-X 1033 Mining	X	-	-	-	-	-	-
MT-X 1033 A Mining	X	-	-	-	-	-	-
MT-X 1440	-	X	X	X	-	-	-
MT-X 1440 A	-	X	X	X	-	-	-
MT-X 1840	-	X	X	X	-	-	-
MT-X 1840 A	-	X	X	X	-	-	-

VERPLICHTE UITRUSTING VAN MACHINES : ✕



NEW

## VAST VORKENBORD (MRT - MHT)



- Pendelende vorken.
- Vorken conform aan de FEM norm, lengte van de vorken afhankelijk van het model.
- Opmerking: Verplichte verkeerskit in Italië. Neem contact op met uw dealer.
- Opmerking: de verkeersset is in Duitsland verplicht op MRTs Vision/Vision+. Neem contact op met uw dealer.
- Een eenvoudige en efficiënte oplossing om goederen te vervoeren.

	CAT 1320 / 6 T (a)	CAT 1320 / 7 T (a)	CAT 1750 / 5 T (a)	CAT 1750 / 7 T (a)	CAT 1750 / 2.5 T	CAT 2000 / 5 T (a)
Capaciteit (lb)	13227.74	15432.36	11023.11	15432.36	5511.56	11023.11
Totale hoogte (in)	3' 2"	3' 2"	2' 8"	3' 1"	2' 8"	2' 8"
Breedte (in)	4' 7"	4' 7"	6'	6'	6'	6' 10"
Machine-apparatuur	×	×	×	×	×	×
Minimum spreiding vorken (in)	1' 1"	1' 3"	1' 7"	1' 3"	1' 7"	1' 7"
Maximum spreiding vorken (in)	3' 11"	4' 1"	5' 7"	5' 7"	5' 7"	6' 1"

## Beschikbare vorkafmetingen

150 x 50 x 1200			52721175			52721208
100 x 60 x 1200	52718348					
150 x 60 x 1200		52655420		52655520		
150 x 50 x 1500			52721176			52721209
100 x 60 x 1500	52718356					
150 x 60 x 1500		52718373		52718375		
100 x 60 x 1800	52718357					
150 x 60 x 1800		52718374		52718377		
150 x 50 x 2000					52721177	52721210

## Machine compatibiliteit

MRT 1645 75	-	-	X	-	X	X
MRT 1645 115	-	-	X	-	X	X
MRT 1845 75	-	-	X	-	X	X
MRT 1845 115	-	-	X	-	X	X
MRT 2145 115	-	-	X	-	X	X
MRT 2260	X	-	-	X	-	-
MRT 2260 e	X	-	-	X	-	-
MRT 2545 115	-	-	X	-	X	X
MRT 2570	-	X	-	X	-	-
MRT 2660	X	-	-	X	-	-
MRT 2660 e	X	-	-	X	-	-
MRT 3060	X	-	-	X	-	-
MRT 3570	-	X	-	X	-	-
MRT 3570 ES	-	X	-	X	-	-
MRT-X 1645	-	-	X	-	X	X
MRT-X 1845	-	-	X	-	X	X
MRT-X 2145	-	-	X	-	X	X
MRT-X 2260	X	-	-	X	-	-
MRT-X 2545	-	-	X	-	X	X
MRT-X 2570	-	X	-	X	-	-
MRT-X 2660	X	-	-	X	-	-
MRT-X 3060	X	-	-	X	-	-
MRT-X 3570	-	X	-	X	-	-
MRT-X 3570 ES	-	X	-	X	-	-

**VERPLICHTE UITRUSTING VAN MACHINES :** ✕

	CAT 2000 / 7 T (a)	PFB 1320 (c4.5)	PFB 1320 (c4.5b)	PFB 1750 (c9)	PFB 2000 (c9)
Capaciteit (lb)	15432.36	9920.80	9920.80	19841.60	19841.60
Totale hoogte (in)	3' 2"	2' 8"	2' 8"	2' 9"	2' 9"
Breedte (in)	6' 10"	4' 7"	4' 7"	6'	6' 10"
Machine-apparatuur	×	×	×	×	×
Minimum spreiding vorken (in)	1' 3"	1' 6"	1' 7"	1' 5"	1' 5"
Maximum spreiding vorken (in)	6' 4"	3' 8"	4' 1"	5' 8"	6' 6"

## Beschikbare vorkafmetingen

125 x 50 x 1200		924877			
150 x 60 x 1200	52655525				
200 x 60 x 1200				939056	939058
150 x 60 x 1500	52718378				
200 x 60 x 1500				53021960	53022163
150 x 50 x 1800			52601398		
150 x 60 x 1800	52718379				
200 x 60 x 2000				53025302	53025305

## Machine compatibiliteit

MHT 790 ST5	-	-	-	X	X
MHT-X 790 Mining	-	-	-	X	X
MHT-X 790 ST3A	-	-	-	X	X
MRT 1645 75	-	X	X	-	-
MRT 1645 115	-	X	X	-	-
MRT 1845 75	-	X	X	-	-
MRT 1845 115	-	X	X	-	-
MRT 2145 115	-	X	X	-	-
MRT 2260	X	-	-	-	-
MRT 2260 e	X	-	-	-	-
MRT 2545 115	-	X	X	-	-
MRT 2570	X	-	-	-	-
MRT 2660	X	-	-	-	-
MRT 2660 e	X	-	-	-	-
MRT 3060	X	-	-	-	-
MRT 3570	X	-	-	-	-
MRT 3570 ES	X	-	-	-	-
MRT-X 1645	-	X	X	-	-
MRT-X 1845	-	X	X	-	-
MRT-X 2145	-	X	X	-	-
MRT-X 2260	X	-	-	-	-
MRT-X 2545	-	X	X	-	-
MRT-X 2570	X	-	-	-	-
MRT-X 2660	X	-	-	-	-
MRT-X 3060	X	-	-	-	-
MRT-X 3570	X	-	-	-	-
MRT-X 3570 ES	X	-	-	-	-

**VERPLICHTE UITRUSTING VAN MACHINES :** ×



## VAST VORKENBORD MET SIDESHIFT (MLT - MT)

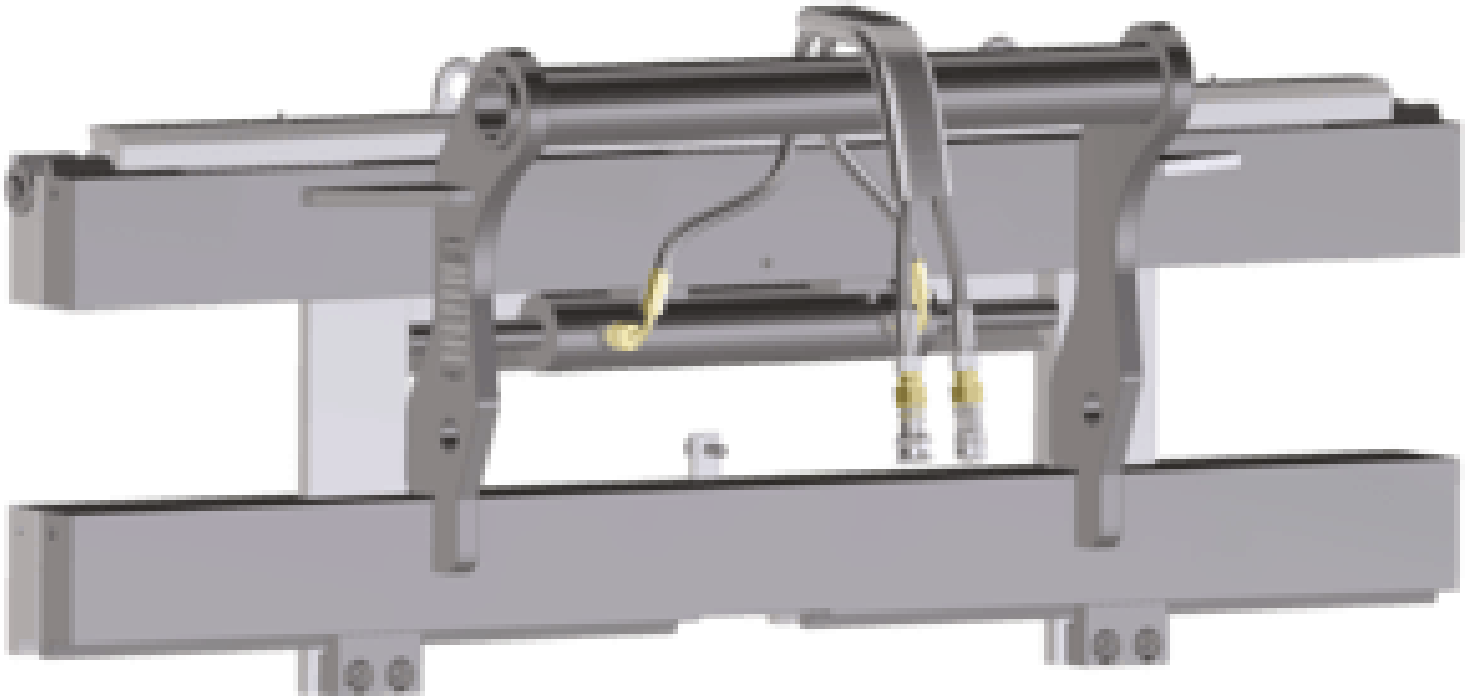

- Hydraulische leiding vereist om vorkbeweging vanuit de cabine mogelijk te maken.
- Kantelbare vorken.
- Vorken volgens FEM/ISO-norm, vorklengte afhankelijk van model.
- Vorken zijn niet inbegrepen in PFB's, bestel 2 eenheden (behalve CAT 1260 / 5T SS + F 150x50x1200).

	PFB 25N 1020 SS	PFB 25N 1260 SS	PFB 35N 1260 SS	PFB 35N 1580 SS	PFB 45N 1670 SS
Capaciteit (lb)	5511.56	5511.56	7716.18	7716.18	9920.80
Gewicht (lb)	297.62	319.67	385.81	661.39	1190.50
Totale hoogte (in)	1' 10"	1' 10"	2' 2"	2' 2"	2' 2"
Breedte (in)	3' 4"	4' 2"	4' 2"	5' 2"	5' 6"
Machine-apparatuur					
Zijverschuiving (in)	4"	4"	4"	4"	4"

## Beschikbare vorkafmetingen

125 x 45 x 1200	52000099	52000100	52000101	52000102	
125 x 50 x 1200					52000103

## Machine compatibiliteit

MLT 625-75 H	X	X	-	-	-
MLT 733-115	-	-	X	-	-
MLT 733-115 LSU	-	-	X	-	-
MLT-X 625-75 H	X	X	-	-	-
MT 625 e	X	X	-	-	-
MT 625 HA	X	X	-	-	-
MT 733 Easy	-	-	X	X	-
MT 735 75D ST5	-	-	X	X	-
MT 933 Easy	-	-	X	X	-
MT 935 75D ST5	-	-	X	X	-
MT 1033 easy	-	-	X	X	-
MT 1135 75 D	-	-	X	X	-
MT 1135 H 100D	-	-	X	X	-
MT 1135 easy ST5	-	-	X	X	-
MT 1135 H easy ST5	-	-	X	X	-
MT 1135 HA Easy ST5	-	-	X	X	-
MT 1135 ST5	-	-	X	X	-
MT 1335 75D ST5	-	-	X	X	-
MT 1335 100D ST5	-	-	X	X	-
MT 1335	-	-	X	X	-
MT 1335 easy ST5	-	-	X	X	-
MT 1335 H 75D ST5	-	-	X	X	-
MT 1335 H 100D ST5	-	-	X	X	-
MT 1335 H easy ST5	-	-	X	X	-
MT 1335 HA 75D ST5	-	-	X	X	-
MT 1335 HA 100D ST5	-	-	X	X	-
MT 1335 HA easy ST5	-	-	X	X	-
MT 1335 ST5	-	-	X	X	-
MT 1440 A	-	-	-	-	X
MT 1440 A ST5	-	-	-	-	X
MT 1440 easy ST5	-	-	-	-	X
MT 1440 HA	-	-	-	-	X
MT 1440 HA ST5	-	-	-	-	X
MT 1440 ST5	-	-	-	-	X



PFB 25N 1020 SS

PFB 25N 1260 SS

PFB 35N 1260 SS

PFB 35N 1580 SS

PFB 45N 1670 SS

## Machine compatibiliteit

	PFB 25N 1020 SS	PFB 25N 1260 SS	PFB 35N 1260 SS	PFB 35N 1580 SS	PFB 45N 1670 SS
MT 1840 A 100D ST5 S1	-	-	-	-	X
MT 1840 A	-	-	-	-	X
MT 1840 easy ST5	-	-	-	-	X
MT 1840 HA	-	-	-	-	X
MT 1840 HA	-	-	-	-	X
MT 1840 ST5	-	-	-	-	X
MT-X 625 H	X	X	-	-	-
MT-X 733	-	-	X	X	-
MT-X 1033	-	-	X	X	-
MT-X 1440	-	-	-	-	X
MT-X 1440 A	-	-	-	-	X
MT-X 1840	-	-	-	-	X
MT-X 1840 A	-	-	-	-	X

**VERPLICHTE UITRUSTING VAN MACHINES :** 









NEW

## VAST VORKENBORD MET SIDESHIFT (MRT - MHT)



- Pendelende vorken.
- Vorken conform aan de FEM norm, lengte van de vorken afhankelijk van het model.
- Constante zijdelingse verschuiving.
- Opmerking: Verplichte verkeerskit in Italië. Neem contact op met uw dealer.
- Opmerking: de verkeersset is in Duitsland verplicht op MRTs Vision/Vision+. Neem contact op met uw dealer.
- Een eenvoudige en efficiënte oplossing om goederen te vervoeren.



	CAT 2000 / 7 T (a)	PFB 1320 (c4.5)	PFB 1320 (c4.5b)	PFB 1320 (c4.9-a)	PFB 1750 (c9)	PFB 2000 (c9)
Capaciteit (lb)	15432.36	9920.80	9920.80	11020.91	19841.60	19841.60
Totale hoogte (in)	3' 3"	2' 8"	2' 8"	2' 8"	2' 9"	2' 10"
Breedte (in)	6' 7"	4' 7"	4' 7"	4' 7"	6'	6' 6"
Machine-apparatuur						
Zijverschuiving (in)	4"	4"	4"	4"	4"	4"
Minimum spreiding vorken (in)	1' 4"	1' 7"	1' 3"	1' 4"	1' 6"	-
Maximum spreiding vorken (in)	6'	4' 1"	4' 3"	4' 4"	5' 5"	6' 2"

## Beschikbare vorkafmetingen

125 x 50 x 1200			924878			
150 x 50 x 1200				921241		
150 x 60 x 1200	52712870					
200 x 60 x 1200					939057	939059
150 x 50 x 1500		921525		921513		
150 x 60 x 1500	52719378					
200 x 60 x 1500					53025304	53025306
150 x 50 x 2000				921514		
150 x 60 x 2000	52719379					
200 x 60 x 2000					53025303	53025307

## Machine compatibiliteit

MHT 790 ST5	-	-	-	-	X	X
MHT-X 790 Mining	-	-	-	-	X	X
MHT-X 790 ST3A	-	-	-	-	X	X
MRT 1645 75	-	X	X	-	-	-
MRT 1645 115	-	X	X	-	-	-
MRT 1845 75	-	X	X	-	-	-
MRT 1845 115	-	X	X	-	-	-
MRT 2145 115	-	X	X	-	-	-
MRT 2260	X	-	X	X	-	-
MRT 2545 115	-	X	X	-	-	-
MRT 2570	X	-	X	X	-	-
MRT 2660	X	-	X	X	-	-
MRT 3060	X	-	X	X	-	-
MRT 3570	X	-	X	X	-	-
MRT 3570 ES	X	-	X	X	-	-
MRT-X 1645	-	X	X	-	-	-
MRT-X 1845	-	X	X	-	-	-
MRT-X 2145	-	X	X	-	-	-
MRT-X 2260	X	-	X	X	-	-
MRT-X 2545	-	X	X	-	-	-
MRT-X 2570	X	-	X	X	-	-
MRT-X 2660	X	-	X	X	-	-
MRT-X 3060	X	-	X	X	-	-
MRT-X 3570	X	-	X	X	-	-

**VERPLICHTE UITRUSTING VAN MACHINES :** 



## VERSTELBARE VORKSCHORT MET LOAD BACKSPLASH (MLT - MT)



- Load splash vastgeschroefd aan het "PFB" schort.
- Opmerking: moet worden gebruikt met FEM-vorken.

	PFB 25N 1020 LB	PFB 25N 1260 LB	PFB 35N 1260 LB	PFB 35N 1470 LB	PFB 45N 1670 LB	PFB 45N 2000 LB
Capaciteit (lb)	5511.56	5511.56	7716.18	7716.18	9920.80	9920.80
Gewicht (lb)	231.49	260.15	286.60	348.33	683.43	793.66
Totale hoogte (in)	3' 10"	3' 11"	3' 11"	3' 11"	4'	4'
Breedte (in)	3' 5"	4' 3"	4' 3"	4' 11"	5' 11"	7'
Machine-apparatuur	×	×	×	×	×	×

## Beschikbare vorkafmetingen

125 x 45 x 1200	52000198	52000199	52000200	52000201		
125 x 50 x 1200					52000202	52000203

## Machine compatibiliteit

ALT950	-	-	X	-	-	-
MLA-T 533-145 V+ - ST5	-	-	X	-	-	-
MLT 625-75 H	X	X	-	-	-	-
MLT 630-115	-	-	X	X	-	-
MLT 630-115 V	-	-	X	X	-	-
MLT 630-115 V CP	-	-	X	X	-	-
MLT 635-130 PS+	-	-	X	X	-	-
MLT 635-140 V+	-	-	X	X	-	-
MLT 730-115 V	-	-	X	X	-	-
MLT 730-115 V CP	-	-	X	X	-	-
MLT 733-115	-	-	X	X	-	-
MLT 733-115 LSU	-	-	X	X	-	-
MLT 737-130 PS+	-	-	-	-	X	X
MLT 741-130 PS+	-	-	-	-	X	X
MLT 741-140 V+	-	-	-	-	X	X
MLT 841-145 PS+	-	-	-	-	X	X
MLT 940-140 V+	-	-	-	-	X	X
MLT 961-160 V+ L	-	-	-	-	X	X
MLT 1041-145 PS+L	-	-	-	-	X	X
MLT-X 625-75 H	X	X	-	-	-	-
MLT-X 735 T LSU	-	-	X	X	-	-
MLT-X 735 T LSU (70 KW)	-	-	X	X	-	-
MLT-X 737-130 PS+	-	-	-	-	X	X
MLT-X 741-140 V+	-	-	-	-	X	X
MLT-X 841 - 145 PS+	-	-	-	-	X	X
MLT-X 961-160 V+ L	-	-	-	-	X	X
MLT-X 1041-145 PS+L	-	-	-	-	X	X
MT 625 e	X	-	-	-	-	-
MT 625 HA	X	-	-	-	-	-
MT 733 Easy	-	-	X	X	-	-
MT 735 75D ST5	-	-	X	X	-	-
MT 933 Easy	-	-	X	X	-	-
MT 935 75D ST5	-	-	X	X	-	-
MT 1033 easy	-	-	X	X	-	-
MT 1135 75 D	-	-	X	X	-	-

	PFB 25N 1020 LB	PFB 25N 1260 LB	PFB 35N 1260 LB	PFB 35N 1470 LB	PFB 45N 1670 LB	PFB 45N 2000 LB
<b>Machine compatibiliteit</b>						
MT 1135 H 100D	-	-	X	X	-	-
MT 1135 easy ST5	-	-	X	X	-	-
MT 1135 H easy ST5	-	-	X	X	-	-
MT 1135 HA Easy ST5	-	-	X	X	-	-
MT 1135 ST5	-	-	X	X	-	-
MT 1335 75D ST5	-	-	X	X	-	-
MT 1335 100D ST5	-	-	X	X	-	-
MT 1335	-	-	X	X	-	-
MT 1335 easy ST5	-	-	X	X	-	-
MT 1335 H 75D ST5	-	-	X	X	-	-
MT 1335 H 100D ST5	-	-	X	X	-	-
MT 1335 H easy ST5	-	-	X	X	-	-
MT 1335 HA 75D ST5	-	-	X	X	-	-
MT 1335 HA 100D ST5	-	-	X	X	-	-
MT 1335 HA easy ST5	-	-	X	X	-	-
MT 1335 ST5	-	-	X	X	-	-
MT 1440 A	-	-	-	-	X	X
MT 1440 A ST5	-	-	-	-	X	X
MT 1440 easy ST5	-	-	-	-	-	X
MT 1440 HA	-	-	-	-	X	X
MT 1440 HA ST5	-	-	-	-	X	X
MT 1440 ST5	-	-	-	-	X	X
MT 1840 A 100D ST5 S1	-	-	-	-	X	X
MT 1840 A	-	-	-	-	X	X
MT 1840 easy ST5	-	-	-	-	-	X
MT 1840 HA	-	-	-	-	X	X
MT 1840 HA	-	-	-	-	X	X
MT 1840 ST5	-	-	-	-	X	X
MT-X 625 H	X	-	-	-	-	-
MT-X 733	-	-	X	X	-	-
MT-X 1033	-	-	X	X	-	-
MT-X 1440	-	-	-	-	X	X
MT-X 1440 A	-	-	-	-	X	X
MT-X 1840	-	-	-	-	X	X
MT-X 1840 A	-	-	-	-	X	X

**VERPLICHTE UITRUSTING VAN MACHINES :** ✕



## VLOTTEND VORKENBORD (MLT - MT)



- Lastrugleuning standaard.
- Vorkenverstelling.
- Oplossing aangepast aan oneffen ondergrond : zwevende vorken + nivellering.

	TFF 35 MT (a)	TFF 35 MT (c)	TFF 35 MT (UK)	TFF 45 MT (a)	TFF 45 MT (c)	TFF 75 MT
Capaciteit (lb)	7716.18	7716.18	7716.18	9920.80	9920.80	16534.67
Breedte (in)	3' 9"	4' 7"	3' 9"	3' 10"	4' 8"	4' 11"
Machine-apparatuur	×	×	×	×	×	×
Maximum spreiding vorken (in)	3' 5"	4' 3"	3' 5"	3' 5"	4' 3"	4' 8"

## Beschikbare vorkafmetingen

125 x 45 x 1200	654093	654094				
100 x 50 x 1200			788793	788794		
125 x 50 x 1200				653344	653345	
200 x 60 x 1200						528083
200 x 60 x 1500						578154

## Machine compatibiliteit

Referentienummer	-	-	-	-	-	504280
MLT 630-115	X	X	-	-	-	-
MLT 630-115 V	X	X	-	-	-	-
MLT 630-115 V CP	X	X	-	-	-	-
MLT 635-130 PS+	X	X	-	-	-	-
MLT 635-140 V+	-	X	-	-	-	-
MLT 730-115 V	X	X	-	-	-	-
MLT 730-115 V CP	X	X	-	-	-	-
MLT 733-115	X	X	-	-	-	-
MLT 733-115 LSU	-	X	-	-	-	-
MLT 737-130 PS+	-	-	-	X	X	-
MLT 741-130 PS+	-	-	-	X	X	-
MLT 741-140 V+	-	-	-	X	X	-
MLT 841-145 PS+	-	-	-	X	X	-
MLT 850-145 V+	-	-	-	-	-	X
MLT 940-140 V+	-	-	-	X	X	-
MLT 961-160 V+ L	-	-	-	-	-	X
MLT 1041-145 PS+L	-	-	-	X	X	-
MLT-X 732	X	-	-	-	-	-
MLT-X 735 T LSU	X	X	-	-	-	-
MLT-X 735 T LSU (70 kW)	X	-	-	-	-	-
MLT-X 737-130 PS+	-	-	-	X	X	-
MLT-X 741-140 V+	-	-	-	X	X	-
MLT-X 841 - 145 PS+	-	-	-	X	X	-
MLT-X 850-145 V+	-	-	-	-	-	X
MLT-X 961-160 V+ L	-	-	-	-	-	X
MLT-X 1035 LT LSU	X	X	-	X	-	-
MLT-X 1041-145 PS+L	-	-	-	X	X	-
MT 733 Easy	X	X	X	-	-	-
MT 933 Easy	X	X	X	-	-	-
MT 1033 easy	X	X	X	-	-	-
MT 1135 easy ST5	X	X	X	-	-	-
MT 1135 H easy ST5	X	X	X	-	-	-



TFF 35 MT (a)	TFF 35 MT (c)	TFF 35 MT (UK)	TFF 45 MT (a)	TFF 45 MT (c)	TFF 75 MT
---------------	---------------	----------------	---------------	---------------	-----------

Machine compatibiliteit						
MT 1135 HA Easy ST5	X	X	X	-	-	-
MT 1135 ST5	X	X	X	-	-	-
MT 1335	X	X	X	-	-	-
MT 1335 easy ST5	X	X	X	-	-	-
MT 1335 H easy ST5	X	X	X	-	-	-
MT 1335 HA easy ST5	-	X	X	-	-	-
MT 1335 ST5	X	X	-	-	-	-
MT 1440 A	-	-	-	X	X	-
MT 1440 A ST5	-	-	-	X	X	-
MT 1440 easy ST5	-	-	-	X	X	-
MT 1440 HA	-	-	-	X	X	-
MT 1440 HA ST5	-	-	-	X	X	-
MT 1440 ST5	-	-	-	X	X	-
MT 1840 A 100D ST5 S1	-	-	-	X	X	-
MT 1840 A	-	-	-	X	X	-
MT 1840 easy ST5	-	-	-	X	X	-
MT 1840 HA	-	-	-	X	X	-
MT 1840 HA	-	-	-	X	X	-
MT 1840 ST5	-	-	-	X	X	-
MT-X 733	X	X	X	-	-	-
MT-X 1033	X	X	X	-	-	-
MT-X 1440	-	-	-	-	X	-
MT-X 1440 A	-	-	-	-	X	-
MT-X 1840	-	-	-	-	X	-
MT-X 1840 A	-	-	-	-	X	-



VERPLICHTE UITRUSTING VAN MACHINES : ✕



## VLOTTEND VORKENBORD MET HYDRAULISCHE SCHUINSTELLING



- Hydraulische niveaucorrectie 10°/10°.
- Vorken met oog 150 x 60 x 1200 mm.
- Capaciteit 4,9t.
- Max. afstand van de vorken 1180 mm (buitenkant van de vorken).
- Gewicht (765 kg) & dikte (280 mm).
- Converte o seu empilhador telescópico num guindaste.
- Acoplamento extremamente rápido no empilhador MANITOU.
- Controlo fácil da direção desde a cabine ou com o controlo remoto da máquina (opcional).
- Movimentos rápidos e precisos.

	TFF 1230 + Levelling (a)	TFF 1230 + Levelling (b)
Capaciteit (lb)	10802.65	10802.65
Gewicht (lb)	1360.25	1686.54
Totale hoogte (in)	4' 8"	4' 8"
Totale lengte (in)	5' 1"	5' 1"
Breedte (in)	4' 4"	4' 4"
Machine-apparatuur		
Maximum spreiding vorken (in)	3' 4"	3' 4"

Beschikbare vorkafmetingen		
125 x 50 x 1200	924876	
150 x 60 x 1200		921240

Machine compatibiliteit		
MRT 1645 75	X	-
MRT 1645 115	X	-
MRT 1845 75	X	-
MRT 1845 115	X	-
MRT 2145 115	X	-
MRT 2260	-	X
MRT 2260 e	-	X
MRT 2545 115	X	-
MRT 2570	-	X
MRT 2660	-	X
MRT 2660 e	-	X
MRT 3060	-	X
MRT 3570	-	X
MRT 3570 ES	-	X
MRT-X 1645	X	-
MRT-X 1845	X	-
MRT-X 2145	X	-
MRT-X 2260	-	X
MRT-X 2545	X	-
MRT-X 2570	-	X
MRT-X 2660	-	X
MRT-X 3060	-	X
MRT-X 3570	-	X
MRT-X 3570 ES	-	X

VERPLICHTE UITRUSTING VAN MACHINES : 



NEW

## VLOTTEND VORKENBORD MET SIDESHIFT (MLT - MT)



- Hydraulic line required to allow fork movement from the cab.
- Pin type forks.
- Bolt-on load backrest for a better longevity.

	TFF 29 DL 1040	TFF 35 DL 1040	TFF 35 DL 1300	TFF 45 DL 1040	TFF 45 DL 1300
Capaciteit (lb)	6393.41	7716.18	7716.18	9920.80	9920.80
Breedte (in)	3' 5"	3' 5"	4' 3"	3' 5"	4' 3"
Machine-apparatuur	☺☺	☺☺	☺☺	☺☺	☺☺

## Beschikbare vorkafmetingen

120 x 40 x 1200	751378				
125 x 45 x 1200		751543	751544		
125 x 50 x 1200				751545	751546

## Machine compatibiliteit

MT 730 H	-	X	-	-	-
MT 733 Easy	-	X	-	-	-
MT 735 75D ST5	-	X	-	-	-
MT 930 H	-	X	-	-	-
MT 930 HA	-	X	-	-	-
MT 933 Easy	-	X	-	-	-
MT 935 75D ST5	-	X	-	-	-
MT 1033 easy	-	X	-	-	-
MT 1135 75 D	-	X	-	-	-
MT 1135 H 100D	-	X	-	-	-
MT 1335 75D ST5	-	X	-	-	-
MT 1335 100D ST5	-	X	-	-	-
MT 1335 H 75D ST5	-	X	-	-	-
MT 1335 H 100D ST5	-	X	-	-	-
MT 1335 HA 75D ST5	-	X	-	-	-
MT 1335 HA 100D ST5	-	X	-	-	-
MT-X 733	-	X	-	-	-
MT-X 1033	-	X	-	-	-
MT 733 Easy	-	-	X	-	-
MT 933 Easy	-	-	X	-	-
MT 1033 easy	-	-	X	-	-
MT 1440 A ST5	-	-	-	X	X
MT 1440 easy ST5	-	-	-	X	X
MT 1440 HA ST5	-	-	-	X	X
MT 1440 ST5	-	-	-	X	X
MT 1840 A 100D ST5 S1	-	-	-	X	X
MT 1840 easy ST5	-	-	-	X	X
MT 1840 HA	-	-	-	X	X
MT 1840 ST5	-	-	-	X	X
MT-X 733	-	-	X	-	-
MT-X 1033	-	-	X	-	-
MT-X 1440	-	-	-	X	X
MT-X 1440 A	-	-	-	X	X
MT-X 1840	-	-	-	X	X
MT-X 1840 A	-	-	-	X	X

TFF 29 DL 1040

TFF 35 DL 1040

TFF 35 DL 1300

TFF 45 DL 1040

TFF 45 DL 1300

## Machine compatibiliteit

MXT 840 K	-	-	-	X	-
MXT 840 P	-	-	-	X	-
MXT 1740 K	-	-	-	X	-
MXT 1740 P	-	-	-	X	-

VERPLICHTE UITRUSTING VAN MACHINES : 





NEW

## VLOTTEND VORKENBORD MET SIDESHIFT (MRT)



- Opmerking: Verplichte verkeerskit in Italië. Neem contact op met uw dealer.
- Opmerking: de verkeersset is in Duitsland verplicht op MRTs Vision/Vision+. Neem contact op met uw dealer.

	TFF 1030 TDL 5 T	TFF 1030 TDL 5 T (b)
Capaciteit (lb)	11023.11	11023.11
Gewicht (lb)	1172.86	1377.89
Totale hoogte (in)	4' 10"	4' 10"
Totale lengte (in)	5' 5"	5' 6"
Breedte (in)	3' 8"	3' 8"
Machine-apparatuur		
Zijverschuiwing (in)	4"	4"
Minimum spreiding vorken (in)	1' 2"	1' 4"
Maximum spreiding vorken (in)	3' 4"	3' 4"

## Beschikbare vorkafmetingen

125 x 50 x 1200	924864	
150 x 60 x 1200		923956

## Machine compatibiliteit

MRT 1645 75	X	X
MRT 1645 115	X	X
MRT 1845 75	X	X
MRT 1845 115	X	X
MRT 2145 115	X	X
MRT 2260	-	X
MRT 2260 e	-	X
MRT 2545 115	X	X
MRT 2570	-	X
MRT 2660	-	X
MRT 2660 e	-	X
MRT 3060	-	X
MRT 3570	-	X
MRT 3570 ES	-	X
MRT-X 1645	X	X
MRT-X 1845	X	X
MRT-X 2145	X	X
MRT-X 2260	-	X
MRT-X 2545	X	X
MRT-X 2570	-	X
MRT-X 2660	-	X
MRT-X 3060	-	X
MRT-X 3570	-	X
MRT-X 3570 ES	-	X

VERPLICHTE UITRUSTING VAN MACHINES : 





## ZIJDELINGSE KANTELBARE VORKDEUR - LOAD BACKSPLASH (MLT - MT)



- Opschroefbare lastrugleuning voor een hogere laststabiliteit.
- Opmerking: te gebruiken met FEM-vorken.

	PFB 45N 1670 SS LB	PFB 25N 1020 SS LB	PFB 35N 1260 SS LB
Capaciteit (lb)	9920.80	5511.56	7716.18
Gewicht (lb)	1311.75	374.79	462.97
Totale hoogte (in)	4' 2"	4'	4'
Breedte (in)	5' 11"	3' 5"	4' 3"
Machine-apparatuur	☐☐	☐☐	☐☐
Zijverschuiving (in)	4"	4"	4"

## Beschikbare vorkafmetingen

125 x 45 x 1200		52000204	52000205
125 x 50 x 1200	52000206		

## Machine compatibiliteit

ALT950	-	-	X
MLA-T 533-145 V+ - ST5	-	-	X
MLT-X 741 T LSU	X	-	-
MT 625 e	-	X	-
MT 625 HA	-	X	-
MT 733 Easy	-	-	X
MT 735 75D ST5	-	-	X
MT 933 Easy	-	-	X
MT 935 75D ST5	-	-	X
MT 1033 easy	-	-	X
MT 1135 75 D	-	-	X
MT 1135 H 100D	-	-	X
MT 1135 H easy ST5	-	-	X
MT 1135 HA Easy ST5	-	-	X
MT 1135 ST5	-	-	X
MT 1335 75D ST5	-	-	X
MT 1335 100D ST5	-	-	X
MT 1335	-	-	X
MT 1335 easy ST5	-	-	X
MT 1335 H 75D ST5	-	-	X
MT 1335 H 100D ST5	-	-	X
MT 1335 H easy ST5	-	-	X
MT 1335 HA 75D ST5	-	-	X
MT 1335 HA 100D ST5	-	-	X
MT 1335 ST5	-	-	X
MT 1440 A	X	-	-
MT 1440 A ST5	X	-	-
MT 1440 easy ST5	X	-	-
MT 1440 HA	X	-	-
MT 1440 HA ST5	X	-	-
MT 1440 ST5	X	-	-
MT 1840 A 100D ST5 S1	X	-	-
MT 1840 A	X	-	-
MT 1840 easy ST5	X	-	-

	PBF 45N 1670 SS LB	PFB 25N 1020 SS LB	PFB 35N 1260 SS LB
<b>Machine compatibiliteit</b>			
MT 1840 HA	X	-	-
MT 1840 HA	X	-	-
MT 1840 ST5	X	-	-
MT-X 733	-	-	X
MT-X 1033	-	-	X
MT-X 1440	X	-	-
MT-X 1440 A	X	-	-
MT-X 1840	X	-	-
MT-X 1840 A	X	-	-

**VERPLICHTE UITRUSTING VAN MACHINES :** 



# VORKEN EN GRIJPERS

Bereik



- 134 Balenvork
- 136 Balenvork (compacte machines)
- 138 Kuilhapper
- 140 Mestklauw met hoge capaciteit

- 142 Mestriek met klauw
- 145 Mestvork (compacte machines)
- 148 Mestvork met klem (compacte machines)
- 152 Vork Bale Katoen **NEW**



## BALENVORK



- Capaciteit van 700 tot 1700 kg.
  - Vouwbaar bajonettanden (zonder gereedschap) voor wegtransport.
  - Hoogste deel van het onderstel, eenvoudige interventies onder het dak.
  - Steuntanden op het hoger gedeelte van het kader.
  - 2 tanden, Ø 35 mm, werklengte van 950 mm.
  - 4 tanden, Ø 45 mm, werklengte van 1010 mm.
- Based on a bucket: cutting edge can be used to scrap packed material.



	FB 950 / 700 LB	FB 1900 / 1700
Capaciteit (lb)	1543.24	3747.86
Gewicht (lb)	189.60	473.99
Totale hoogte (in)	3' 1"	7' 4"
Totale lengte (in)	4' 2"	4' 5"
Lengte vorken (in)	3' 1"	3' 4"
Breedte over vorken (in)	3' 2"	2'
Breedte (in)	3' 8"	6' 2"
Machine-apparatuur	×	×
Tanden	2	4

Machine compatibiliteit		
Referentienummer	52595597	790699
ALT950	-	X
MLA-T 533-145 V+ - ST5	-	X
MLT 420-60 H	X	-
MLT 625-75 H	-	X
MLT 630-115	-	X
MLT 630-115 V	-	X
MLT 630-115 V CP	-	X
MLT 635-130 PS+	-	X
MLT 635-140 V+	-	X
MLT 730-115 V	-	X
MLT 730-115 V CP	-	X
MLT 733-115	-	X
MLT 733-115 LSU	-	X
MLT 841-145 PS+	-	X
MLT 850-145 V+	-	X
MLT 940-140 V+	-	X
MLT 961-160 V+ L	-	X
MLT 1041-145 PS+L	-	X
MLT-X 625-75 H	-	X
MLT-X 732	-	X
MLT-X 735 T LSU	-	X
MLT-X 741 T LSU	-	X
MLT-X 841 - 145 PS+	-	X
MLT-X 850-145 V+	-	X
MLT-X 961-160 V+ L	-	X
MLT-X 1041-145 PS+L	-	X

**VERPLICHTE UITRUSTING VAN MACHINES : ×**



## BALENVORK (COMPACTE MACHINES)

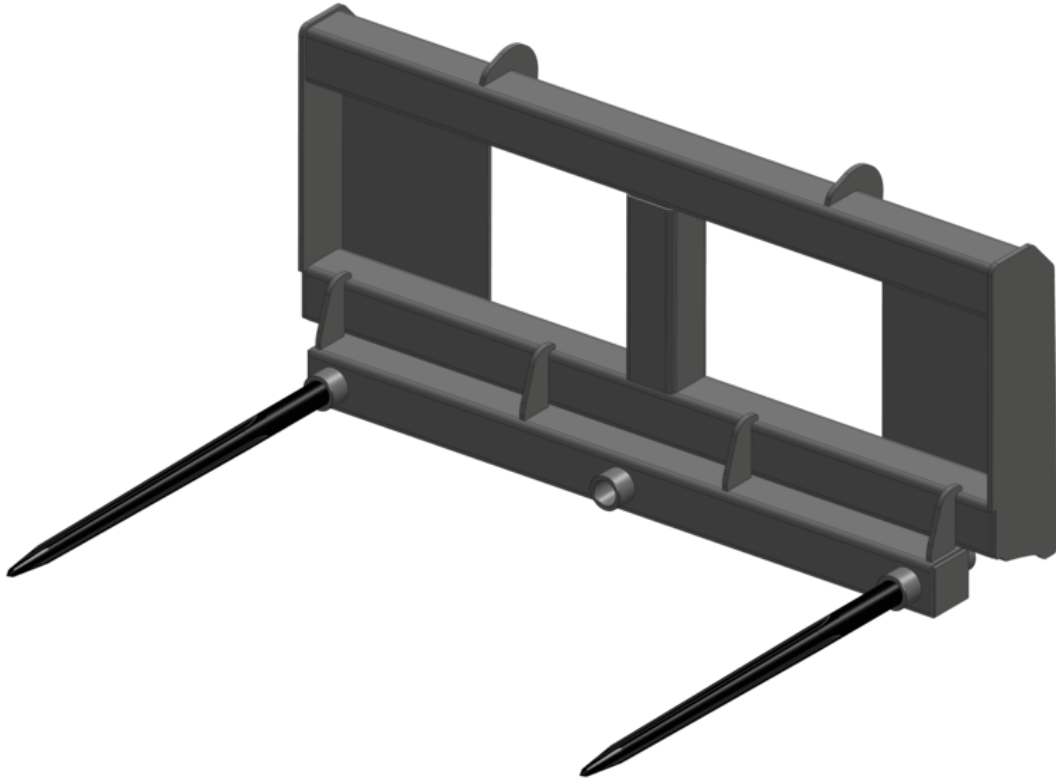

- 2 robuuste gesmede tanden.
- LB : uitvoering met laststeun.

- Eenvoudige en economische aankoppeling om alle soorten balen te verhandelen.
- De beste economische keuze: goed prijs/kwaliteit verhouding en breed inzetbaar.



	FB 950 / 700	FB 950 / 700 LB	FB 1110
Capaciteit (lb)	1543.24	1543.24	1234.59
Gewicht (lb)	160.94	158.73	165.35
Totale hoogte (in)	2'	3' 6"	1' 10"
Totale lengte (in)	2' 9"	4'	3' 11"
Lengte vorken (in)	2' 2"	3' 1"	3' 2"
Breedte (in)	3' 9"	3' 8"	3' 10"
Diepte (in)	2' 8"	4'	3' 8"
Machine-apparatuur	×	×	×
Tanden	2	2	2

Machine compatibiliteit			
All-Tach® Narrow	N51502699	N51502698	-
All-Tach®	N51502684	N51502687	N747028
4 point Carriage	N51502685	N51502688	-
Euro Carriage	N51502686	N51502689	-
1650 R	-	-	X
1650 RT	-	-	X
1900 R	-	-	X
2100V	-	-	X
2200 R	-	-	X
2300V	-	-	X
2600 R	-	-	X
2700 V NXT:2	-	-	X
2750V	-	-	X
AL550	X	X	-
AL650	X	X	-
AL750	X	X	-
GCT 3-14	-	X	-
GCT 3-14 +	-	X	-
MLA 5-60 H-Z	X	X	-
MLA 6-65 H-Z	X	X	-
MLA 7-75 H-Z	X	X	-
R165	-	-	X
R190	-	-	X
R220	-	-	X
RT165	-	-	X
ULM 412 H	-	X	-
ULM 412 H	-	X	-
ULM 415 H	-	X	-
ULM 415 H	-	X	-
V210 - NEW	-	-	X
V230 - NEW	-	-	X
V275 - NEW	-	-	X

**VERPLICHTE UITRUSTING VAN MACHINES :** ×







## KUILHAPPER



- Versterkte structuur, stijfheid en levensduur.
- Body in hoog resistent staal.
- Tandens in hoog resistent staal voor een beter snijeffect.
- De zijdelingse structuren laten een goede indringing in de hoop toe, met een nauwkeurig snijeffect.
- Cilinders met grote diameter om krachtig te kunnen werken.
- Vastgeboute snijtanden voor een eenvoudiger onderhoud (behalve SHG 1700/850 : gelaste tanden).
- Efficiënt en precies snijden van silovoer.
- Zuivere snede om het fermenteren van het voer te vermijden.
- Een krachtig accessoire om snel te kunnen snijde.
- De structuur is achteraan gesloten om het verlies van voer te beperken.



	SHG 1600 / 1200	SHG 1800 / 1350	SHG 2200 / 1650	SHG 2400 / 1800
Capaciteit (lb)	2319.26	2610.27	3190.09	3481.10
Capaciteit van de koepel (US gal)	308.82	347.39	424.79	463.36
Gewicht (lb)	1554.26	1651.26	1840.86	2063.53
Totale lengte (in)	4' 3"	4' 3"	4' 3"	4' 3"
Breedte (in)	5' 5"	6' 1"	7' 5"	8' 1"
Gesloten grijphoogte (in)	3' 4"	3' 4"	3' 4"	3' 4"
Geopende grijphoogte (in)	4' 10"	4' 10"	4' 10"	4' 10"
Diepte (in)	2' 9"	2' 9"	2' 9"	2' 9"
Machine-apparatuur				
Tanden	14	14	14	14

Machine compatibiliteit				
Referentienummer	52000380	52000381	52000382	52000383
ALT950	-	-	X	-
MLA-T 533-145 V+ - ST5	-	-	X	-
MLT 625-75 H	X	-	-	-
MLT 630-115	-	X	-	-
MLT 630-115 V	-	X	-	-
MLT 630-115 V CP	-	X	-	-
MLT 635-130 PS+	-	-	X	-
MLT 635-140 V+	-	-	X	-
MLT 730-115 V	-	X	-	-
MLT 730-115 V CP	-	X	-	-
MLT 733-115	-	-	-	X
MLT 733-115 LSU	-	-	-	X
MLT 737-130 PS+	-	-	-	X
MLT 741-130 PS+	-	-	-	X
MLT 741-140 V+	-	-	-	X
MLT 841-145 PS+	-	-	-	X
MLT 850-145 V+	-	-	-	X
MLT 940-140 V+	-	-	-	X
MLT 1041-145 PS+L	-	-	-	X
MLT-X 625-75 H	X	-	-	-
MLT-X 732	-	-	X	-
MLT-X 735 T LSU	-	-	X	-
MLT-X 737-130 PS+	-	-	-	X
MLT-X 741-140 V+	-	-	-	X
MLT-X 841 - 145 PS+	-	-	-	X
MLT-X 850-145 V+	-	-	-	X
MLT-X 1041-145 PS+L	-	-	-	X

**VERPLICHTE UITRUSTING VAN MACHINES :** 





## MESTKLAUW MET HOGE CAPACITEIT



- Grote capaciteit 2000 L.
- Grijper uitgerust met mechanische stoppen voor een langere levensduur van de cilinders.
- Geschroefde tanden en vingers voor eenvoudige onderhoudsbeurten.
- Algemeen gebruik van hoog resistent staal.
- Tandens: Ø 45 mm, 939 mm.
- Vingers: Ø 45 mm, 1100 mm.
- Effiziente Schneeräumung & perfekte Oberflächenreinigung in einem Rutsch.



	FMG 2100 / 1800 ONLY UK IRL	FMG 2450 / 2000
Capaciteit (lb)	2777.82	-
Capaciteit van de koepel (US gal)	475.51	528.34
Gewicht (lb)	1124.36	1512.37
Totale lengte (in)	4' 5"	4' 6"
Lengte vorken (in)	3' 3"	3' 3"
Breedte (in)	6' 11"	8'
Gesloten grijphoogte (in)	4'	3' 11"
Machine-apparatuur		
Tanden / Vingers	4 / 10	5 / 12
Minimum spreiding vorken (in)	9"	8"
Maximum spreiding vorken (in)	2' 1"	1' 10"

Machine compatibiliteit		
Referentienummer	52000082	790534
MLT 630-115	X	-
MLT 630-115 V	X	-
MLT 630-115 V CP	X	-
MLT 635-130 PS+	-	X
MLT 635-140 V+	-	X
MLT 733-115	-	X
MLT 733-115 LSU	-	X
MLT 737-130 PS+	-	X
MLT 741-130 PS+	-	X
MLT 741-140 V+	-	X
MLT 841-145 PS+	-	X
MLT 850-145 V+	-	X
MLT 940-140 V+	-	X
MLT 961-160 V+ L	-	X
MLT 1041-145 PS+L	-	X
MLT-X 732	-	X
MLT-X 735 T LSU	-	X
MLT-X 737-130 PS+	-	X
MLT-X 741-140 V+	-	X
MLT-X 741 T LSU	-	X
MLT-X 841 - 145 PS+	-	X
MLT-X 850-145 V+	-	X
MLT-X 961-160 V+ L	-	X
MLT-X 1041-145 PS+L	-	X

**VERPLICHTE UITRUSTING VAN MACHINES :** 



## MESTRIEK MET KLAUW



- Massieve structuur en versterkte grijper voor een langere levensduur.
- Open structuur.
- Mest wordt zeer goed bij gehouden door de grijper.
- Opening van de grijper regelbaar zonder werktuigen, om nauwkeuriger te werken.
- Gesmede tanden en vingers eenvoudig af te nemen.
- Zeer goede bescherming van de hydraulische componenten.
- Robuust en veelzijdig.
- Gemakkelijk verwerken van compacte mest.
- De volledige opening van de kaken laten toe om langs een muur te werken.
- Veelzijdige constructie waarmee occasioneel vierkante balen kunnen gemanipuleerd worden.
- Goed zicht om sneller te kunnen werken.



	FFGR 1500 / 600	FFGR 1500 / 900	FFGR 1700	FFGR 1950	FFGR 1950 DA	FFGR 2100	FFGR 2400
Capaciteit (lb)	1587.33	2458.15	-	3483.30	3483.30	3747.86	3747.86
Capaciteit van de koepel (US gal)	158.50	245.68	277.38	264.17	264.17	290.59	343.42
Gewicht (lb)	749.57	963.42	1113.33	1051.60	1168.45	1084.67	1164.04
Totale lengte (in)	4' 2"	4' 4"	4' 4"	4' 4"	4' 4"	4' 4"	4' 4"
Lengte vorken (in)	2' 8"	2' 8"	2' 8"	2' 8"	2' 8"	2' 8"	2' 8"
Breedte over vorken (in)	9"	9"	9"	9"	9"	9"	9"
Breedte (in)	5'	5' 4"	5' 7"	6' 5"	6' 5"	6' 11"	7' 10"
Gesloten grijphoogte (in)	2' 11"	3' 9"	3' 8"	3' 9"	3' 8"	3' 9"	3' 9"
Geopende grijphoogte (in)	5' 6"	6' 2"	6' 10"	5' 4"	6' 10"	5' 4"	5' 4"
Machine-apparatuur	☺☺	☺☺	☺☺	☺☺	☺☺	☺☺	☺☺
Tanden / Vingers	7 / 7	7 / 7	8 / 7	9 / 7	9 / 7	10 / 7	12 / 8

## Machine compatibiliteit

Referentienummer	-	52595596	751429	751404	751428	751403	751405
All-Tach®	52737500	-	-	-	-	-	-
4 point Carriage	52742068	-	-	-	-	-	-
Euro Carriage	52742069	-	-	-	-	-	-
GCT 3-14	X	-	-	-	-	-	-
GCT 3-14 +	X	-	-	-	-	-	-
MLT 420-60 H	-	X	-	-	-	-	-
MLT 625-75 H	-	-	X	-	X	-	-
MLT 630-115	-	-	-	X	-	X	X
MLT 630-115 V	-	-	-	X	-	X	X
MLT 630-115 V CP	-	-	-	X	-	X	X
MLT 635-130 PS+	-	-	-	-	-	X	X
MLT 635-140 V+	-	-	-	-	-	X	X
MLT 730-115 V	-	-	-	X	-	X	X
MLT 730-115 V CP	-	-	-	X	-	X	X
MLT 733-115	-	-	-	-	-	X	X
MLT 733-115 LSU	-	-	-	-	-	X	X
MLT 737-130 PS+	-	-	-	-	-	X	X
MLT 741-130 PS+	-	-	-	-	-	X	X
MLT 741-140 V+	-	-	-	-	-	X	X
MLT 841-145 PS+	-	-	-	-	-	-	X
MLT 850-145 V+	-	-	-	-	-	-	X
MLT 940-140 V+	-	-	-	-	-	X	X
MLT 1041-145 PS+L	-	-	-	-	-	-	X
MLT-X 625-75 H	-	-	X	-	X	-	-
MLT-X 732	-	-	-	-	-	X	X
MLT-X 735 T LSU	-	-	-	-	-	X	X
MLT-X 737-130 PS+	-	-	-	-	-	X	X
MLT-X 741-140 V+	-	-	-	-	-	X	X
MLT-X 741 T LSU	-	-	-	-	-	X	X
MLT-X 841 - 145 PS+	-	-	-	-	-	-	X
MLT-X 850-145 V+	-	-	-	-	-	-	X
MLT-X 1041-145 PS+L	-	-	-	-	-	-	X

FFGR 1500 / 600	FFGR 1500 / 900	FFGR 1700	FFGR 1950	FFGR 1950 DA	FFGR 2100	FFGR 2400
-----------------	-----------------	-----------	-----------	--------------	-----------	-----------

Machine compatibiliteit							
ULM 412 H	X	-	-	-	-	-	-
ULM 412 H	X	-	-	-	-	-	-
ULM 415 H	X	-	-	-	-	-	-
ULM 415 H	X	-	-	-	-	-	-

VERPLICHTE UITRUSTING VAN MACHINES : 





## MESTVORK (COMPACTE MACHINES)

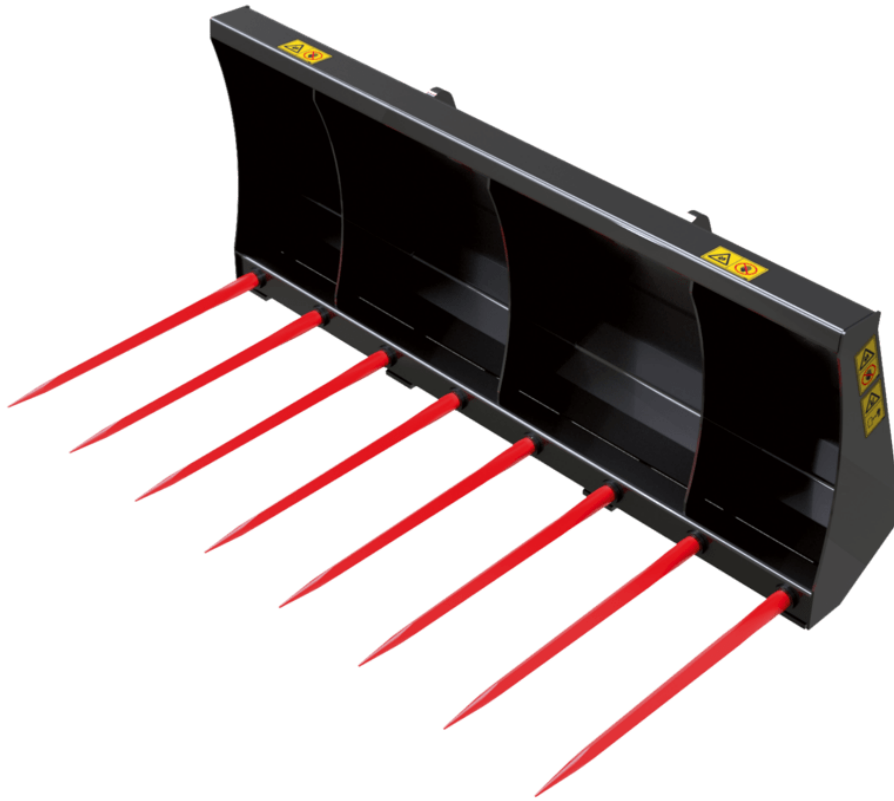

- Robuuste en eenvoudige constructie.
- Robuuste tanden.
- Onmisbaar werktuig om mest en balen te verhandelen.

	FM 915	FM 1080	FM 1200 (b)	FM 1400	FM 1520	FM 1650	FM 1680
Gewicht (lb)	160.94	352.74	240.30	352.74	374.79	403.45	295.42
Totale hoogte (in)	1' 11"	1' 11"	2' 3"	1' 11"	1' 11"	2' 4"	2'
Breedte (in)	3'	3' 7"	3' 11"	4' 7"	5'	5' 5"	5' 6"
Diepte (in)	2' 8"	2' 8"	2' 9"	2' 11"	2' 11"	3' 5"	2' 10"
Machine-apparatuur	×	×	×	×	×	×	×

Machine compatibiliteit							
All-Tach®	N726020	N726021	-	N736026	N736027	N51502515	N747023
4 point Carriage	-	-	-	-	-	N51502624	-
Euro Carriage	-	-	N51502173	-	-	N51502583	-
850 R	X	X	-	-	-	-	-
1050 R	-	-	-	X	-	-	-
1050 RT	-	-	-	X	X	-	-
1350 R NXT2	-	-	-	X	X	-	-
1350 RT	-	-	-	X	X	-	-
1640 E	X	X	-	-	-	-	-
1650 R	-	-	-	-	-	-	X
1650 RT	-	-	-	-	-	-	X
1900 R	-	-	-	-	-	-	X
2100V	-	-	-	-	-	-	X
2100VT	-	-	-	-	-	-	X
AL650	-	-	X	-	-	X	-
AL750	-	-	-	-	-	X	-
MLA 6-65 H-Z	-	-	X	-	-	X	-
MLA 7-75 H-Z	-	-	-	-	-	X	-
R105	-	-	-	X	-	-	-
R135	-	-	-	X	X	-	-
R165	-	-	-	-	-	-	X
R190	-	-	-	-	-	-	X
RT105	-	-	-	X	X	-	-
RT135	-	-	-	X	X	-	-
RT165	-	-	-	-	-	-	X
V210 - NEW	-	-	-	-	-	-	X
VT210 - NEW	-	-	-	-	-	-	X

	FM 1760	FM 1850 (a)	FM 1850 (b)	FM 1880	FM 1950	FM 2140	FM 2150
Gewicht (lb)	1785.74	337.31	337.31	337.31	476.20	374.79	513.68
Totale hoogte (in)	2'	2'	2'	2'	2' 4"	2'	2' 4"
Breedte (in)	5' 9"	6' 1"	6' 1"	6' 2"	6' 5"	7'	7' 1"
Diepte (in)	2' 10"	2' 10"	2' 10"	2' 10"	3' 5"	2' 10"	3' 5"
Machine-apparatuur	×	×	×	×	×	×	×







Machine compatibiliteit							
All-Tach®	N757030	N757031	N51502480	N51502080	N51502514	N700260	N51502513
4 point Carriage	-	-	-	-	N51502625	-	N51502626
Euro Carriage	-	-	-	-	N51502584	-	N51502585
2200 R	X	-	X	-	-	-	-
2300V	X	-	X	-	-	-	-
2600 R	-	X	X	X	-	-	-
2700 V NXT:2	-	X	X	X	-	-	-
2750V	-	X	X	X	-	-	-
3300 V NXT:2	-	X	X	X	-	X	-
4200 V	-	-	-	-	-	X	-
AL650	-	-	-	-	X	-	-
AL750	-	-	-	-	X	-	X
MLA 6-65 H-Z	-	-	-	-	X	-	-
MLA 7-75 H-Z	-	-	-	-	X	-	X
R220	X	-	-	-	-	-	-
R260	-	X	X	X	-	-	-
V230 - NEW	X	-	X	-	-	-	-
V270	-	X	X	X	-	-	-
V275 - NEW	-	X	X	X	-	-	-
V330	-	X	X	X	-	X	-



## MESTVORK MET KLEM (COMPACTE MACHINES)









- Grijper opent volledig om efficiënt te werken.
- Robuuste tanden.
- Werktuig ontworpen voor landbouwtoepassingen.

	FMG 920 / 240 (b)	FMG 1080 / 290	FMG 1100 / 320	FMG 1200 / 320 (a)	FMG 1200 / 320 (b)	FMG 1400 / 380	FMG 1500 / 380
Capaciteit van de koepel (US gal)	63.40	76.61	76.61	84.54	84.54	100.39	100.39
Gewicht (lb)	264.55	286.60	319.67	317.47	299.83	330.69	363.76
Totale hoogte (in)	2' 5"	2' 5"	2' 5"	2' 5"	2' 5"	2' 5"	2' 5"
Breedte (in)	3'	3' 7"	3' 7"	3' 11"	3' 11"	4' 7"	4' 11"
Diepte (in)	3'	3'	2' 9"	3'	3'	2' 9"	2' 9"
Machine-apparatuur							
Tanden / Vingers	3 / 5	3 / 6	6	3 / 6	3 / 6	4 / 7	4 / 8







Machine compatibiliteit							
All-Tach® Narrow	-	-	-	52799524	-	-	-
All-Tach®	N726022	N726023	-	-	N736028	N736029	N736030
4 point Carriage	-	-	-	52796387	-	-	-
Euro Carriage	-	-	52807870	52799523	-	-	-
850 R	X	X	-	-	-	-	-
1050 R	-	-	-	-	X	X	X
1050 RT	-	-	-	-	X	X	X
1350 R NXT2	-	-	-	-	-	X	X
1350 RT	-	-	-	X	X	X	X
1640 E	X	X	-	-	-	-	-
AL230	-	-	X	-	-	-	-
AL320	-	-	X	-	-	-	-
AL330	-	-	X	-	-	-	-
AL420	-	-	X	-	-	-	-
AL430	-	-	X	-	-	-	-
MLA 2-25 H	-	-	X	-	-	-	-
MLA 3-25 H	-	-	X	-	-	-	-
MLA 3-25 H-C	-	-	X	-	-	-	-
MLA 4-50 H	-	-	X	-	-	-	-
MLA 4-50 H-C	-	-	X	-	-	-	-
R105	-	-	-	-	X	X	X
R135	-	-	-	-	-	X	X
RT105	-	-	-	-	X	X	X
RT135	-	-	-	-	X	X	X

VERPLICHTE UITRUSTING VAN MACHINES : 

	FMG 1500 / 540	FMG 1650	FMG 1680 / 600 (a)	FMG 1680 / 600 (b)	FMG 1760 / 620 (a)	FMG 1760 / 620 (b)	FMG 1850 / 660 (a)
Capaciteit van de koepel (US gal)	142.65	174.35	158.50	158.50	163.79	163.79	174.35
Gewicht (lb)	469.58	661.39	529.11	529.11	551.16	551.16	617.29
Totale hoogte (in)	2' 7"	2' 10"	2' 7"	2' 7"	2' 7"	2' 7"	2' 7"
Breedte (in)	4' 11"	5' 5"	5' 6"	5' 6"	5' 9"	5' 9"	6' 1"
Diepte (in)	3' 4"	3' 5"	3' 4"	3' 4"	3' 4"	3' 4"	3' 4"
Machine-apparatuur							
Tanden / Vingers	8	6 / 8	4 / 9	4 / 9	4 / 9	4 / 9	4 / 10

Machine compatibiliteit							
All-Tach® Narrow	-	-	-	-	-	-	-
All-Tach®	52799529	N51502512	N747025	N51502056	N51502481	N51502057	N757033
4 point Carriage	52799527	N51502627	-	-	-	-	-
Euro Carriage	52799528	N51502586	-	-	-	-	-
1650 R	-	-	X	-	-	-	-
1650 RT	-	-	X	-	-	-	-
1850 RT	-	-	-	X	-	X	-
1900 R	-	-	X	-	-	-	-
2100V	-	-	X	-	-	-	-
2100VT	-	-	-	X	-	X	-
2200 R	-	-	-	-	X	-	-
2300V	-	-	-	-	X	-	-
2600 R	-	-	-	-	-	-	X
2700 V NXT:2	-	-	-	-	-	-	X
2750V	-	-	-	-	-	-	X
3300 V NXT:2	-	-	-	-	-	-	X
4200 V	-	-	-	-	-	-	X
AL550	X	-	-	-	-	-	-
AL650	-	X	-	-	-	-	-
AL750	-	X	-	-	-	-	-
MLA 5-60 H-Z	X	-	-	-	-	-	-
MLA 6-65 H-Z	-	X	-	-	-	-	-
MLA 7-75 H-Z	-	X	-	-	-	-	-
R165	-	-	X	-	-	-	-
R190	-	-	X	-	-	-	-
R220	-	-	-	-	X	-	-
R260	-	-	-	-	-	-	X
RT165	-	-	X	-	-	-	-
RT185	-	-	-	X	-	X	-
V210 - NEW	-	-	X	-	-	-	-
V230 - NEW	-	-	-	-	X	-	-
V270	-	-	-	-	-	-	X
V275 - NEW	-	-	-	-	-	-	X
V330	-	-	-	-	-	-	X
VT210 - NEW	-	-	-	X	-	X	-

VERPLICHTE UITRUSTING VAN MACHINES : 

	FMG 1850 / 660 (b)	FMG 1850 / 660 (c)	FMG 1880 / 660	FMG 1950	FMG 2140 / 760 (a)	FMG 2140 / 760 (b)	FMG 2150
Capaciteit van de koepel (US gal)	174.35	174.35	174.35	206.05	200.77	200.77	227.19
Gewicht (lb)	617.29	617.29	617.29	760.59	683.43	683.43	804.69
Totale hoogte (in)	2' 7"	2' 7"	2' 7"	2' 10"	2' 7"	2' 7"	2' 10"
Breedte (in)	6' 1"	6' 1"	6' 2"	6' 5"	7'	7'	7' 1"
Diepte (in)	3' 4"	3' 4"	3' 4"	3' 5"	3' 4"	3' 4"	3' 5"
Machine-apparatuur							
Tanden / Vingers	4 / 10	4 / 10	4 / 10	8 / 10	4 / 11	4 / 11	8 / 11

Machine compatibiliteit							
All-Tach® Narrow	-	-	-	-	-	-	-
All-Tach®	N51502482	N51502058	N51502081	N51502511	N700261	N51502059	N51502510
4 point Carriage	-	-	-	N51502628	-	-	N51502629
Euro Carriage	-	-	-	N51502587	-	-	N51502588
1850 RT	-	X	-	-	-	-	-
2100VT	-	X	-	-	-	-	-
2150 RT	-	X	-	-	-	X	-
2200 R	X	-	-	-	-	-	-
2300V	X	-	-	-	-	-	-
2300VT	-	X	-	-	-	-	-
2600 R	-	-	X	-	-	-	-
2700 V NXT:2	-	-	X	-	-	-	-
2750V	-	-	X	-	X	-	-
2750VT	-	X	-	-	-	X	-
3300 V NXT:2	-	-	X	-	X	-	-
4200 V	-	-	-	-	X	-	-
AL650	-	-	-	X	-	-	-
AL750	-	-	-	X	-	-	X
MLA 6-65 H-Z	-	-	-	X	-	-	-
MLA 7-75 H-Z	-	-	-	X	-	-	X
R220	X	-	-	-	-	-	-
R260	-	-	X	-	-	-	-
RT185	-	X	-	-	-	-	-
RT215	-	X	-	-	-	X	-
V230 - NEW	X	-	-	-	-	-	-
V270	-	-	X	-	-	-	-
V275 - NEW	-	-	X	-	X	-	-
V330	-	-	X	-	X	-	-
VT210 - NEW	-	X	-	-	-	-	-
VT230 - NEW	-	X	-	-	-	-	-
VT275 - NEW	-	X	-	-	-	X	-

VERPLICHTE UITRUSTING VAN MACHINES : 



NEW

# VORK BALE KATOEN

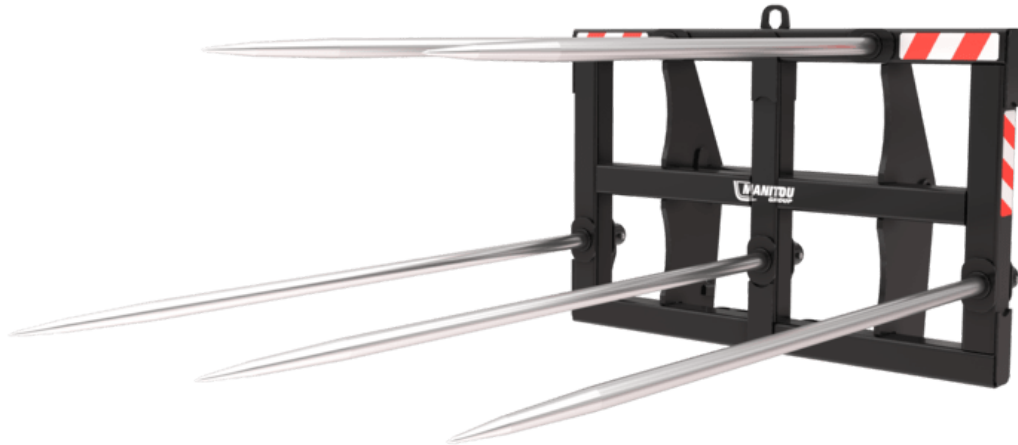

- 5000 kg capaciteit.
- 2 tanden, Ø 50 mm, werklengte 2000 mm.
- 3 tanden, Ø 50 mm, werklengte 2300 mm.
- Afneembare tanden (gemakkelijk te vervangen, te verzenden en op te slaan in het laagseizoen).



	<b>FBC 5 / 5000</b>
Capaciteit (lb)	11023.11
Gewicht (lb)	855.39
Totale hoogte (in)	3' 6"
Totale lengte (in)	8' 2"
Breedte (in)	5'
Machine-apparatuur	×
Tines length (in)	6' 7"
Tanden / Vingers	2 / 3

**Machine compatibiliteit**

Referentienummer	52775361
MLT 850-145 V+	X
MLT-X 850-145 V+	X

**VERPLICHTE UITRUSTING VAN MACHINES : ×**



# GIEKEN

Bereik



156 Big bag handler

160 Op frame gemonteerd haak



## BIG BAG HANDLER



- Max. totale capaciteit van 4000 kg, 4 haken van elk 1000 kg.
- Stopvoorziening gelast bij elke haak, vermindert het risico van vallende zaken bij vergissing van de operator.
- Demper achteraan om het zwenken van de zakken tegen te gaan.
- Vergemakkelijkt het manipuleren van big bags op een veilige manier. De structuur met ronde buizen beschadigt de big bags niet en beperkt de kans op vallen. De verhoogde structuur laat toe om een trailer te laden zonder het dakzeil te beschadigen. Vervoert zowel big bags met 1, 2 of 4 lussen.



	HBB 1500 / 2400	HBB 2100 / 4000
Capaciteit (lb)	5291.09	8818.49
Gewicht (lb)	410.06	628.32
Totale hoogte (in)	4' 4"	4' 4"
Totale lengte (in)	5' 5"	7' 2"
Breedte over vorken (in)	2' 6"	2' 4"
Breedte (in)	4' 5"	4' 5"
Machine-apparatuur	×	×

Machine compatibiliteit		
Referentienummer	52781808	52691660
Referentievorkenbord schranklader	52578030	-
4 point Carriage	52742058	-
Euro Carriage	52742059	-
ALT950	X	-
GCT 3-14	X	-
GCT 3-14 +	X	-
MLA-T 533-145 V+ - ST5	X	-
MLT 420-60 H	X	-
MLT 625-75 H	X	-
MLT 630-115	X	-
MLT 630-115 V	X	-
MLT 630-115 V CP	X	-
MLT 635-130 PS+	X	-
MLT 635-140 V+	X	-
MLT 730-115 V	X	-
MLT 730-115 V CP	X	-
MLT 733-115	X	-
MLT 733-115 LSU	X	-
MLT 737-130 PS+	X	-
MLT 741-130 PS+	X	-
MLT 841-145 PS+	X	-
MLT 850-145 V+	X	X
MLT 940-140 V+	X	-
MLT 961-160 V+ L	X	X
MLT 1041-145 PS+L	X	-
MLT-X 625-75 H	X	-
MLT-X 732	X	-
MLT-X 735 T LSU	X	-
MLT-X 737-130 PS+	X	-
MLT-X 741-140 V+	X	-
MLT-X 741 T LSU	X	-
MLT-X 841 - 145 PS+	X	-
MLT-X 850-145 V+	X	X
MLT-X 961-160 V+ L	X	X
MLT-X 1035 LT LSU	X	-

	HBB 1500 / 2400	HBB 2100 / 4000
Machine compatibiliteit		
MLT-X 1041-145 PS+L	X	-
MRT 1645 75	X	-
MRT 1645 115	X	-
MRT 1845 75	X	-
MRT 1845 115	X	-
MRT 2145 115	X	-
MRT 2260	X	-
MRT 2260 e	X	-
MRT 2545 115	X	-
MRT 2570	X	-
MRT 2660	X	-
MRT 2660 e	X	-
MRT 3060	X	-
MRT 3570	X	-
MRT 3570 ES	X	-
MRT-X 1645	X	-
MRT-X 1845	X	-
MRT-X 2145	X	-
MRT-X 2260	X	-
MRT-X 2545	X	-
MRT-X 2570	X	-
MRT-X 2660	X	-
MRT-X 3060	X	-
MRT-X 3570	X	-
MRT-X 3570 ES	X	-
MT 420 H	X	-
MT 625 e	X	-
MT 625 HA	X	-
MT 733 Easy	X	-
MT 735 75D ST5	X	-
MT 933 Easy	X	-
MT 935 75D ST5	X	-
MT 1033 easy	X	-
MT 1135 75 D	X	-
MT 1135 H 100D	X	-
MT 1135 H easy ST5	X	-
MT 1135 ST5	X	-
MT 1335 75D ST5	X	-
MT 1335 100D ST5	X	-
MT 1335	X	-
MT 1335 H 75D ST5	X	-
MT 1335 H 100D ST5	X	-
MT 1335 HA 75D ST5	X	-
MT 1335 HA 100D ST5	X	-

	HBB 1500 / 2400	HBB 2100 / 4000
<b>Machine compatibiliteit</b>		
MT 1335 ST5	X	-
MT 1440 A	X	-
MT 1440 HA	X	-
MT 1840 A	X	-
MT 1840 HA	X	-
MT-X 625 H	X	-
MT-X 733	X	-
MT-X 1033	X	-
MT-X 1440	X	-
MT-X 1440 A	X	-
MT-X 1840	X	-
MT-X 1840 A	X	-
MXT 840 K	X	-
MXT 840 P	X	-
MXT 1740 K	X	-
MXT 1740 P	X	-
ULM 412 H	X	-
ULM 412 H	X	-
ULM 415 H	X	-
ULM 415 H	X	-

**VERPLICHTE UITRUSTING VAN MACHINES :** ✕



## OP FRAME GEMONTEERD HAAK



- Breed gamma van 4000 kg tot 6000 kg.
- Rechstreekse aanbouw op de aankoppeling van de machine.
- Veiligheid: Gehomologeerde en zelfsluitende zwenkhaak.
- Eenvoudige en kostefficiënte oplossing om opgehangen lasten te verplaatsen

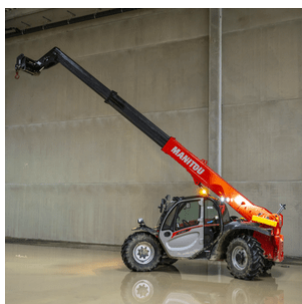



	JH 2500	PC 50	PC 60
Max. bereik (in)	1' 8"	1' 7"	1' 7"
Capaciteit (lb)	5511.56	11023.11	13227.74
Gewicht (lb)	187.39	253.53	264.55
Totale hoogte (in)	2'	1' 8"	1' 8"
Totale lengte (in)	2' 2"	2'	2'
Breedte (in)	2' 3"	2' 8"	2' 8"
Machine-apparatuur	×	×	×

## Machine compatibiliteit

Referentienummer	-	708544	939050
All-Tach®	52579090	-	-
4 point Carriage	52742070	-	-
Euro Carriage	52742071	-	-
ALT950	-	X	-
GCT 3-14	X	-	-
GCT 3-14 +	X	-	-
MLA-T 533-145 V+ - ST5	-	X	-
MLT 420-60 H	-	X	-
MLT 625-75 H	-	X	-
MLT 841-145 PS+	-	X	-
MLT 850-145 V+	-	X	-
MLT 961-160 V+ L	-	-	X
MLT 1041-145 PS+L	-	X	-
MLT-X 625-75 H	-	X	-
MLT-X 741 T LSU	-	X	-
MLT-X 841 - 145 PS+	-	X	-
MLT-X 850-145 V+	-	X	-
MLT-X 961-160 V+ L	-	-	X
MLT-X 1041-145 PS+L	-	X	-
MT 420 H	-	X	-
MT 625 e	-	X	-
MT 625 HA	-	X	-
MT 733 Easy	-	X	-
MT 735 75D ST5	-	X	-
MT 933 Easy	-	X	-
MT 935 75D ST5	-	X	-
MT 1033 easy	-	X	-
MT 1135 75 D	-	X	-
MT 1135 H 100D	-	X	-
MT 1135 ST5	-	X	-
MT 1335 75D ST5	-	X	-
MT 1335 100D ST5	-	X	-
MT 1335	-	X	-
MT 1335 H 75D ST5	-	X	-
MT 1335 H 100D ST5	-	X	-

	JH 2500	PC 50	PC 60
<b>Machine compatibiliteit</b>			
MT 1335 HA 75D ST5	-	X	-
MT 1335 HA 100D ST5	-	X	-
MT 1335 ST5	-	X	-
MT 1440 A	-	X	-
MT 1440 HA	-	X	-
MT 1840 A	-	X	-
MT 1840 HA	-	X	-
MT-X 625 H	-	X	-
MT-X 733	-	X	-
MT-X 733 Mining	-	X	-
MT-X 1033	-	X	-
MT-X 1033 Mining	-	X	-
MT-X 1033 A Mining	-	X	-
MT-X 1440	-	X	-
MT-X 1440 A	-	X	-
MT-X 1840	-	X	-
MT-X 1840 A	-	X	-
ULM 412 H	X	-	-
ULM 412 H	X	-	-
ULM 415 H	X	-	-
ULM 415 H	X	-	-
<b>Referentienummer E-RECO</b>	-	<b>921335</b>	<b>939050</b>
MRT 1645 75	-	X	X
MRT 1645 115	-	X	X
MRT 1845 75	-	X	X
MRT 1845 115	-	X	X
MRT 2145 115	-	X	X
MRT 2260	-	X	X
MRT 2260 e	-	X	X
MRT 2545 115	-	X	X
MRT 2570	-	X	X
MRT 2660	-	X	X
MRT 2660 e	-	X	X
MRT 3060	-	X	X
MRT 3570	-	X	X
MRT 3570 ES	-	X	X
MRT-X 1645	-	X	X
MRT-X 1845	-	X	X
MRT-X 2145	-	X	X
MRT-X 2260	-	X	X
MRT-X 2545	-	X	X
MRT-X 2570	-	X	X
MRT-X 2660	-	X	X
MRT-X 3060	-	X	X

JH 2500	PC 50	PC 60
---------	-------	-------

Machine compatibiliteit			
MRT-X 3570	-	X	X
MRT-X 3570 ES	-	X	X

VERPLICHTE UITRUSTING VAN MACHINES : ✕



# VEEGMACHINES

Bereik



- 166 2-in-1 borstelmaschine
- 169 borstelmaschine met opvangbak
- 171 Hoge druk reiniger

- 173 Orienteerbare borstel (compacte machines)
- 175 Rubberblad (compacte machines)
- 177 Veegbak (compacte machines)



## 2-IN-1 BORSTELMACHINE



- Beschermd hydraulisch systeem, zonder retour naar de bak.
- Synchronisatieklep: vegen en de opvangbak controleren met één enkele hydraulische functie.
- Gegalvaniseerde structuur voor een langere levensduur.
- Synthetische bezem Ø 520 mm.
- Zijdelingse borstel Ø 320 mm in optie.
- Standaard uitvoering: standaard wielen, mechanische zijverstelling.
- "+" uitvoering : versterkte wielen, mechanische zijverstelling.
- "HWA +" uitvoering: versterkte wielen, hydraulische verstelling, watertoediening.
- Beperking MLA, MRT : Buitentemperatuur < 33°C, gebruik < 2 uur per dag.
- Eenvoudige en efficiënte oplossing voor lichte en halfzware veegtoepassingen.
- Opvangbak. Standaard wiel vooraan.
- Veegmachine met opvang en veegmachine



	SCC 2050	SCC 2050 +	SCC 2050 HWA +	SCC 2600	SCC 2600 +	SCC 2600 HWA +
Capaciteit van de koepel (US gal)	52.83	52.83	52.83	66.04	66.04	66.04
Gewicht (lb)	1388.91	1410.96	1521.19	1664.49	1609.37	1763.70
Totale hoogte (in)	3' 1"	3' 1"	5' 1"	3' 1"	3' 1"	5' 1"
Totale lengte (in)	7'	7' 1"	7' 1"	7'	7' 1"	7' 1"
Breedte (in)	7' 5"	7' 5"	7' 5"	9' 3"	9' 3"	9' 3"
Machine-apparaatuur	☐☐	☐☐	☐☐	☐☐	☐☐	☐☐
Water sprayer and hydraulic swivel	Nee	Nee	Ja	Nee	Nee	Ja
Rotatie 1	30	30	30	30	30	30

## Machine compatibiliteit

Referentienummer	52000514	52000516	52000518	52000515	52000517	52000519
ALT950	-	-	-	X	X	X
MHT 790 ST5	-	-	-	-	X	-
MHT-X 790 ST3A	-	-	-	-	X	-
MLA-T 533-145 V+ - ST5	-	X	-	X	X	X
MLT 420-60 H	X	X	X	-	-	-
MLT 625-75 H	X	X	X	-	-	-
MLT 635-130 PS+	-	-	-	X	X	X
MLT 635-140 V+	-	-	-	X	X	X
MLT 841-145 PS+	-	-	-	X	X	X
MLT 850-145 V+	-	-	-	X	X	X
MLT 940-140 V+	-	-	-	X	X	-
MLT 961-160 V+ L	-	-	-	X	-	X
MLT 1041-145 PS+L	-	-	-	X	X	X
MLT-X 625-75 H	X	X	X	-	-	-
MLT-X 732	-	-	-	X	X	X
MLT-X 735 T LSU	-	-	-	X	X	X
MLT-X 741 T LSU	-	-	-	X	X	X
MLT-X 841 - 145 PS+	-	-	-	X	X	X
MLT-X 850-145 V+	-	-	-	X	X	X
MLT-X 961-160 V+ L	-	-	-	X	-	X
MLT-X 1041-145 PS+L	-	-	-	X	X	X
MRT 1645 75	-	-	-	-	X	-
MRT 1645 115	-	-	-	-	X	-
MRT 1845 75	-	-	-	-	X	-
MRT 1845 115	-	-	-	-	X	-
MRT 2145 115	-	-	-	-	X	-
MRT 2545 115	-	-	-	-	X	-
MRT-X 1645	-	-	-	-	X	-
MRT-X 1845	-	-	-	-	X	-
MRT-X 2145	-	-	-	-	X	-
MRT-X 2545	-	-	-	-	X	-
MT 420 H	X	X	X	-	-	-
MT 625 e	X	X	X	-	-	-
MT 625 HA	X	X	X	-	-	-

SCC 2050	SCC 2050 +	SCC 2050 HWA +	SCC 2600	SCC 2600 +	SCC 2600 HWA +
----------	------------	----------------	----------	------------	----------------

Machine compatibiliteit						
MT 733 Easy	-	X	X	X	X	-
MT 735 75D ST5	-	-	-	X	X	X
MT 933 Easy	-	-	-	X	X	X
MT 935 75D ST5	-	-	-	X	X	X
MT 1033 easy	-	-	-	X	X	X
MT 1135 75 D	-	-	-	X	X	X
MT 1135 H 100D	-	-	-	X	X	X
MT 1135 H easy ST5	X	-	X	X	X	X
MT 1335 75D ST5	-	-	-	X	X	X
MT 1335 100D ST5	-	-	-	X	X	X
MT 1335	X	X	X	X	X	X
MT 1335 H 75D ST5	-	-	-	X	X	X
MT 1335 H 100D ST5	-	-	-	X	X	X
MT 1335 HA 75D ST5	-	-	-	X	X	X
MT 1335 HA 100D ST5	-	-	-	X	X	X
MT-X 625 H	X	X	X	-	-	-
MT-X 733	-	-	-	X	X	X
MT-X 1033	-	X	X	X	X	X

**VERPLICHTE UITRUSTING VAN MACHINES :** 







## BORSTELMACHINE MET OPVANGBAK



- Vlottende kader om een verplettering van de accessoire te vermijden bij het werken op oneffen terrein.
  - Zijdelingse borstel in polyester van  $\varnothing$  230mm in gegalvaniseerd staal.
  - Synchronisatieklep: vegen en de opvangbak controleren met één enkele hydraulische functie.
  - Drukbeugler voor krachtige accessoires.
  - Hoofdborstel met een  $\varnothing$  600mm.
  - All-terrein wielen: 4x  $\varnothing$  200mm.
  - Aanbevolen optie: continu oliedebiet.
- Economia de tempo nas manipulações de resíduos.
  - Acessório ideal para manipulação de materiais a granel (papel, resíduos verdes triturados, etc.).
  - Perfeito para trabalhar em concreto, asfalto, etc.
  - Caçamba reforçada para aplicações intensivas de resíduos.



	BRB 1600	BRB 2200	BRB 2500
Capaciteit van de koepel (US gal)	100.39	140.01	158.50
Gewicht (lb)	1708.58	2039.28	2204.62
Totale hoogte (in)	3' 6"	3' 6"	3' 6"
Totale lengte (in)	7' 9"	7' 9"	7' 9"
Breedte (in)	6' 7"	8' 6"	9' 6"
Machine-apparatuur			

Machine compatibiliteit			
Referentienummer	790313	790315	790316
MLT 625-75 H	X	-	-
MLT 635-130 PS+	-	X	-
MLT 635-140 V+	-	X	-
MLT 841-145 PS+	-	X	-
MLT 850-145 V+	-	X	-
MLT 961-160 V+ L	-	X	X
MLT 1041-145 PS+L	-	X	-
MLT-X 625-75 H	X	-	-
MLT-X 735 T LSU	-	X	-
MLT-X 741 T LSU	-	X	-
MLT-X 841 - 145 PS+	-	X	-
MLT-X 850-145 V+	-	X	-
MLT-X 961-160 V+ L	-	X	X
MLT-X 1041-145 PS+L	-	X	-
MT 625 e	X	-	-
MT 625 HA	X	-	-
MT-X 625 H	X	-	-

**VERPLICHTE UITRUSTING VAN MACHINES :**  + 



## HOGE DRUK REINIGER



- Tankcapaciteit 600 L.
- Hydraulische waterpomp.
- Druk regelbaar tussen 10 en 200 bar.
- Standaard met manometer.
- Dop op houder, 40 m slang.
- Krachtige en doeltreffende reiniging.
- 45 min autonomie aan 200 bar.
- Smitkop op lans, 40 m darm.
- Aangepast aan alle reinigings- of onderhoudswerkzaamheden.
- Eenvoudige aankoppeling op de standaard vorken.



	VHPC 600
Capaciteit van de koepel (US gal)	158.50
Gewicht (lb)	529.11
Totale hoogte (in)	4' 11"
Totale lengte (in)	3' 11"
Breedte (in)	4' 9"
Lengte kabel (in)	1' 4"
Machine-apparatuur	

Machine compatibiliteit	
Referentienummer	790335
MLT 635-130 PS+	X
MLT 635-140 V+	X
MLT 841-145 PS+	X
MLT 850-145 V+	X
MLT 961-160 V+ L	X
MLT 1041-145 PS+L	X
MLT-X 625-75 H	X
MLT-X 735 T LSU	X
MLT-X 741 T LSU	X
MLT-X 841 - 145 PS+	X
MLT-X 850-145 V+	X
MLT-X 961-160 V+ L	X
MLT-X 1041-145 PS+L	X









**VERPLICHTE UITRUSTING VAN MACHINES :**  + 



## ORIENTEERBARE BORSTEL (COMPACTE MACHINES)



- Draaibaar 30 ° naar links/rechts.
- Veeg doeltreffend elk ondergrond om vuiligheid en stof te verwijderen.
- Robuust gebouwd, hydromotor met rechtstreekse aandrijving.

	SCA 1530	SCA 1680	SCA 1750	SCA 1850	SCA 1900	SCA 2080 (a)	SCA 2080 (b)	SCA 2140
Gewicht (lb)	881.85	903.90	859.80	925.94	881.85	903.90	903.90	-
Totale hoogte (in)	2' 3"	2' 3"	2' 3"	2' 3"	2' 3"	2' 3"	2' 3"	-
Breedte (in)	5' 9"	6' 3"	5' 9"	6' 10"	6' 3"	6' 10"	6' 10"	7'
Diepte (in)	4' 4"	4' 4"	4' 4"	4' 4"	4' 4"	4' 4"	4' 4"	-
Machine-apparatuur								
Horizontal angle (°)	30	30	30	30	30	30	30	-

Machine compatibiliteit								
All-Tach® Narrow	N004040	-	-	-	-	-	-	-
All-Tach®	N004041	N004042	N51502366	N004043	N51502367	N51502370	N51502496	N51502055
4 point Carriage	N51502377	N51502378	-	N51502379	-	-	-	-
Euro Carriage	N51502381	N51502382	-	N51502383	-	-	-	-
1050 RT	-	-	X	-	X	-	-	-
1350 R NXT2	-	-	X	-	X	-	-	-
1350 RT	-	-	X	-	X	-	-	-
1650 R	-	-	-	-	X	-	-	-
1650 RT	-	-	X	-	X	-	-	-
1850 RT	-	-	-	-	-	-	-	X
1900 R	-	-	-	-	-	-	X	-
2150 RT	-	-	-	-	-	-	-	X
2200 R	-	-	-	-	-	-	X	-
2600 R	-	-	-	-	-	-	X	-
2700 V NXT:2	-	-	-	-	-	X	-	-
AL550	X	X	-	X	-	-	-	-
MLA 5-60 H-Z	X	X	-	X	-	-	-	-
R135	-	-	X	-	X	-	-	-
R165	-	-	-	-	X	-	-	-
R190	-	-	-	-	-	-	X	-
R220	-	-	-	-	-	-	X	-
R260	-	-	-	-	-	-	X	-
RT105	-	-	X	-	X	-	-	-
RT135	-	-	X	-	X	-	-	-
RT165	-	-	X	-	X	-	-	-
RT185	-	-	-	-	-	-	-	X
RT215	-	-	-	-	-	-	-	X
V270	-	-	-	-	-	X	-	-



## RUBBERBLAD (COMPACTE MACHINES)

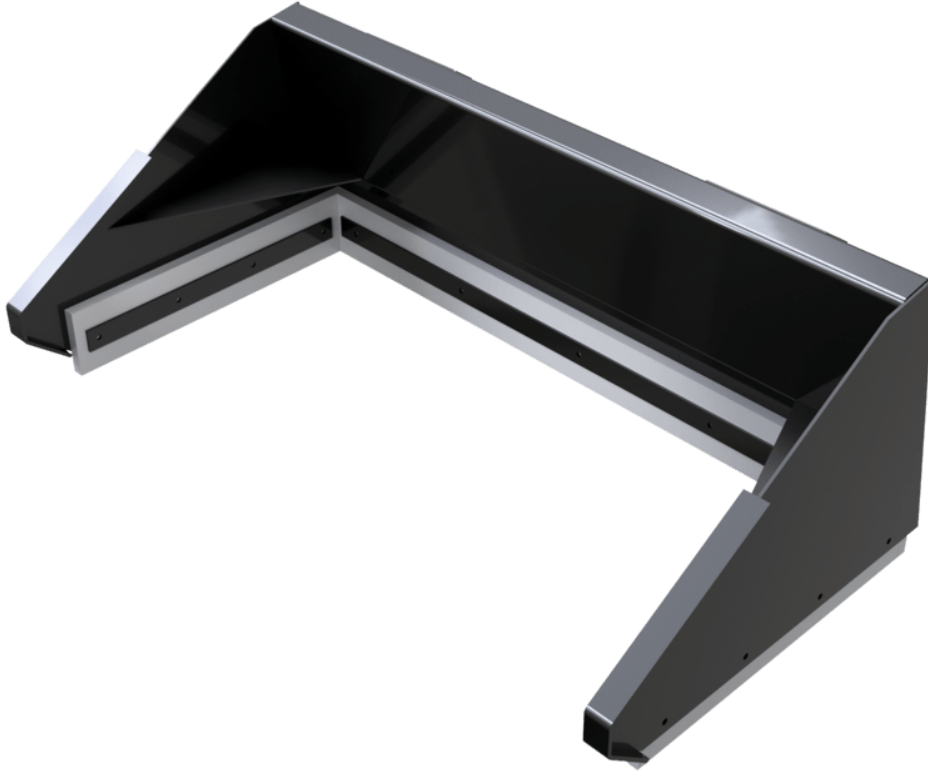

- Bodem uitgerust met een rubberen bescherming.
- Een perfecte reiniging rond de erfgebouwen is eenvoudig.
- Zeer eenvoudige en doeltreffende aankoppeling.

	BLSS 1800 (a)	BLSS 1800 (b)	BLSS 1890 (a)	BLSS 1890 (b)
Gewicht (lb)	273.37	273.37	304.24	304.24
Totale hoogte (in)	2'	2'	2'	2'
Breedte (in)	5' 11"	5' 11"	6' 2"	6' 2"
Diepte (in)	2' 11"	2' 11"	2' 11"	2' 11"
Machine-apparatuur	×	×	×	×

## Machine compatibiliteit

All-Tach®	N757036	N51502498	N757037	N51502499
2300V	-	X	-	-
2600 R	-	X	-	X
2700 V NXT:2	X	-	X	-
2750V	X	-	X	X
R260	-	X	-	X
V230 - NEW	-	X	-	-
V270	X	-	X	-
V275 - NEW	X	-	X	X







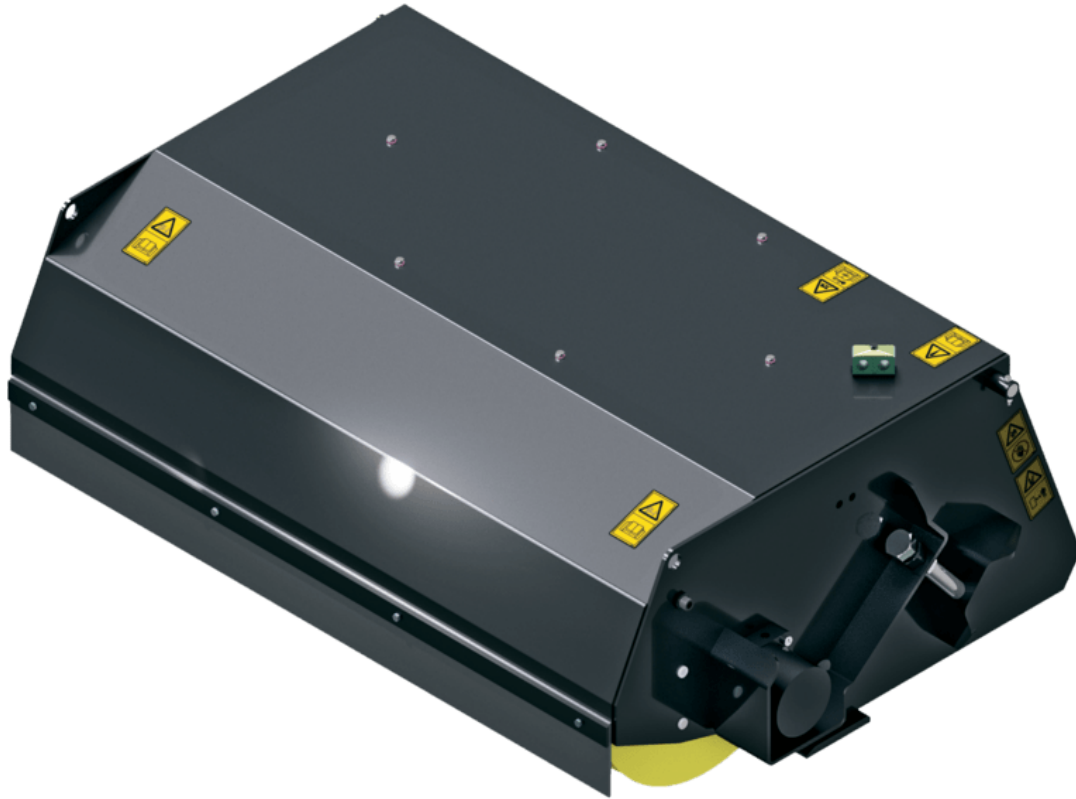



## VEEGBAK (COMPACTE MACHINES)







- Robuuste bouw en componenten deftig beschermd : bezemsecties in polypropyleen.
- Om te vegen en op te vegen in één werkgang.
- Op basis van een bak: het snijeffect kan worden gebruikt om gewikkelde materialen te verwijderen.

	SCB 1120 (b)	SCB 1370	SCB 1525 (a)	SCB 1525 (b)	SCB 1525 (c)	SCB 1680 (a)
Gewicht (lb)	518.09	683.43	762.80	762.80	824.53	947.99
Totale hoogte (in)	2' 2"	2' 2"	2' 2"	2' 2"	2' 1"	2' 3"
Breedte (in)	4' 6"	5' 4"	5' 10"	5' 10"	5' 8"	6' 4"
Diepte (in)	3' 11"	4'	4'	4'	4' 4"	4' 3"
Machine-apparatuur						
Working width - angled (in)	3' 8"	4' 6"	5'	5'	5'	5' 6"

Machine compatibiliteit						
All-Tach®	N726029	N736038	N004038	N736039	52715996	N747032
4 point Carriage	-	-	-	-	52741071	-
Euro Carriage	-	-	-	-	52741070	-
850 R	X	-	-	-	-	-
1050 R	-	X	-	X	-	-
1050 RT	-	X	-	X	-	-
1350 R NXT2	-	X	-	X	-	-
1350 RT	-	X	X	X	-	-
1640 E	X	-	-	-	-	-
1650 R	-	-	-	-	-	X
1650 RT	-	-	-	-	-	X
1900 R	-	-	-	-	-	X
AL230	X	-	-	-	-	-
AL320	X	-	-	-	-	-
AL330	X	-	-	-	-	-
GCT 3-14	-	-	-	-	X	-
GCT 3-14 +	-	-	-	-	X	-
MLA 2-25 H	X	-	-	-	-	-
MLA 3-25 H	X	-	-	-	-	-
MLA 3-25 H-C	X	-	-	-	-	-
MLA 5-50 H	-	-	-	X	-	-
R105	-	X	-	X	-	-
R135	-	X	-	X	-	-
R165	-	-	-	-	-	X
R190	-	-	-	-	-	X
RT105	-	X	-	X	-	-
RT135	-	X	-	X	-	-
RT165	-	-	-	-	-	X
ULM 412 H	-	-	-	-	X	-
ULM 412 H	-	-	-	-	X	-
ULM 415 H	-	-	-	-	X	-
ULM 415 H	-	-	-	-	X	-

**VERPLICHTE UITRUSTING VAN MACHINES :** 

	SCB 1680 (b)	SCB 1850 (a)	SCB 1850 (b)	SCB 2080	SCB 2140
Gewicht (lb)	947.99	1014.13	1014.13	1157.43	1344.82
Totale hoogte (in)	2' 3"	2' 3"	2' 3"	2' 3"	2' 3"
Breedte (in)	6' 4"	6' 11"	6' 11"	10'	7' 10"
Diepte (in)	4' 3"	4' 4"	4' 3"	4' 3"	4' 3"
Machine-apparatuur					
Working width - angled (in)	5' 6"	6' 1"	6' 1"	6' 10"	7'

Machine compatibiliteit					
All-Tach®	N51502049	N757045	N51502050	N700266	N51502051
4 point Carriage	-	-	-	-	-
Euro Carriage	-	-	-	-	-
1850 RT	X	-	X	-	-
2150 RT	-	-	X	-	X
2200 R	-	X	-	-	-
2600 R	-	X	-	X	-
2700 V NXT:2	-	X	-	X	-
3300 V NXT:2	-	X	-	X	-
4200 V	-	X	-	X	-
R220	-	X	-	-	-
R260	-	X	-	X	-
RT185	X	-	X	-	-
RT215	-	-	X	-	X
V270	-	X	-	X	-
V330	-	X	-	X	-

**VERPLICHTE UITRUSTING VAN MACHINES :** 



# LEVELLING SOLUTIONS

Bereik

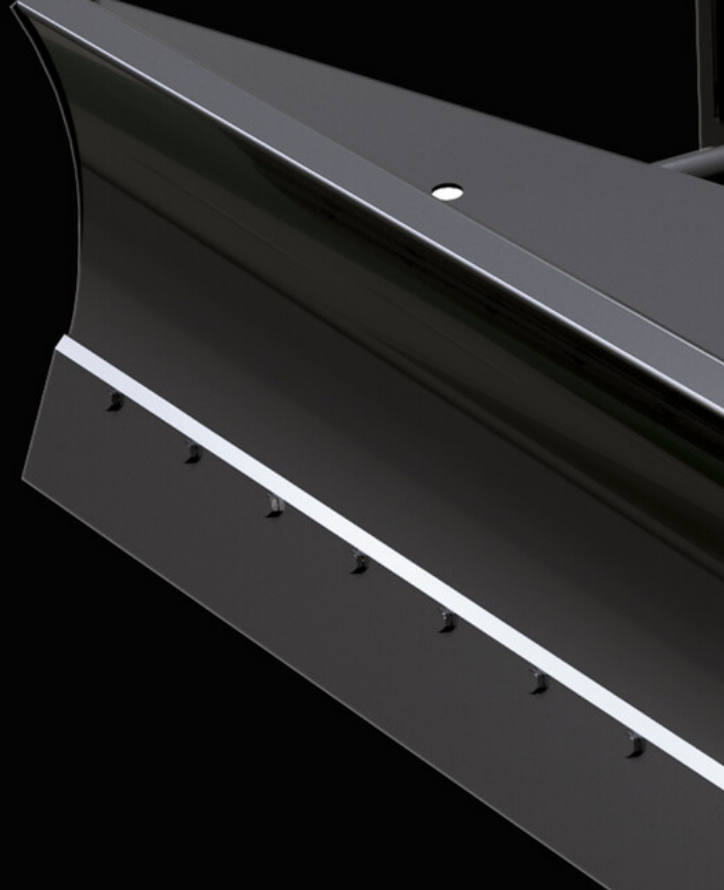

182 Hydr. Dozer blad (compacte machines)

185 Manueel Dozer blad (compacte machines)



## HYDR. DOZER BLAD (COMPACTE MACHINES)







- Hydraulische zijverstelling, traploos en gebruiksvriendelijk (2 cilinders).
- Vastgebouten slijtstukken.
- Voor alle toepassingen om materialen te duwen.

	BLD 1080 H	BLD 1480 H	BLD 1800 H (a)	BLD 1800 H (b)	BLD 1800 H (c)
Gewicht (lb)	429.90	507.06	595.25	595.25	672.41
Totale hoogte (in)	3' 2"	2' 3"	2' 3"	2' 3"	2' 3"
Breedte (in)	3' 7"	4' 10"	5' 11"	5' 11"	5' 11"
Diepte (in)	2' 8"	2' 8"	2' 8"	2' 8"	2' 8"
Machine-apparatuur					
Horizontal angle (°)	18	18	18	18	18

Machine compatibiliteit					
All-Tach®	N726033	N736037	N757043	N51502490	N51502491
850 R	X	-	-	-	-
1050 R	-	X	-	-	-
1050 RT	-	X	-	-	-
1350 R NXT2	-	X	-	-	-
1350 RT	-	X	-	-	-
1640 E	X	-	-	-	-
1650 R	-	-	X	-	-
1650 RT	-	-	X	-	-
1900 R	-	-	-	X	-
2100V	-	-	-	X	-
2200 R	-	-	-	X	-
2300V	-	-	-	X	-
2600 R	-	-	-	-	X
2750V	-	-	-	-	X
R105	-	X	-	-	-
R135	-	X	-	-	-
R165	-	-	X	-	-
R190	-	-	-	X	-
R220	-	-	-	X	-
R260	-	-	-	-	X
RT105	-	X	-	-	-
RT135	-	X	-	-	-
RT165	-	-	X	-	-
V210 - NEW	-	-	-	X	-
V230 - NEW	-	-	-	X	-
V275 - NEW	-	-	-	-	X

**VERPLICHTE UITRUSTING VAN MACHINES :**

	BLD 2000 H (a)	BLD 2000 H (b)	BLD 2135 H	BLD 2365 H
Gewicht (lb)	672.41	672.41	1036.17	1124.36
Totale hoogte (in)	2' 3"	2' 3"	2' 3"	2' 3"
Breedte (in)	6' 7"	6' 7"	7'	7' 9"
Diepte (in)	2' 8"	2' 8"	2' 8"	3' 1"
Machine-apparatuur				
Horizontal angle (°)	18	18	30	30

Machine compatibiliteit				
All-Tach®	N757044	N51502492	N51502085	N700264
2300VT	-	-	X	-
2600 R	-	X	-	-
2700 V NXT:2	X	-	-	-
2750V	-	X	-	-
2750VT	-	-	X	-
3300 V NXT:2	-	-	X	-
4200 V	-	-	-	X
R260	-	X	-	-
V270	X	-	-	-
V275 - NEW	-	X	-	-
V330	-	-	X	-
VT230 - NEW	-	-	X	-
VT275 - NEW	-	-	X	-

**VERPLICHTE UITRUSTING VAN MACHINES :** 





## MANUEEL DOZER BLAD (COMPACTE MACHINES)



- Zijverstelling : mechanisch of hydraulisch (2 cilinders).
- Vastgeboute slijtstukken.
- Voor alle toepassingen om materialen te duwen.

	BLD 1080	BLD 1480	BLD 1800 (a)	BLD 1800 (b)	BLD 2000 (a)	BLD 2000 (b)
Gewicht (lb)	297.62	407.86	451.95	451.95	634.93	634.93
Totale hoogte (in)	2' 3"	2' 3"	2' 3"	2' 3"	2' 3"	2' 3"
Breedte (in)	3' 7"	4' 10"	5' 11"	5' 11"	6' 7"	6' 7"
Diepte (in)	2' 8"	2' 8"	2' 8"	2' 8"	2' 8"	2' 8"
Machine-apparatuur	×	×	×	×	×	×
Horizontaal angle (°)	30	30	30	30	30	30

Machine compatibiliteit						
All-Tach®	N726032	N736036	N51502488	N757041	N51502489	N757042
850 R	X	-	-	-	-	-
1050 R	-	X	-	-	-	-
1050 RT	-	X	-	-	-	-
1350 R NXT2	-	X	-	-	-	-
1350 RT	-	X	-	-	-	-
1640 E	X	-	-	-	-	-
1650 R	-	-	X	-	-	-
1650 RT	-	-	-	X	-	-
1900 R	-	-	-	X	-	-
2100V	-	-	-	X	-	-
2200 R	-	-	-	X	-	-
2300V	-	-	-	X	-	-
2600 R	-	-	-	X	-	X
2700 V NXT:2	-	-	-	-	X	-
2750V	-	-	-	-	X	-
R105	-	X	-	-	-	-
R135	-	X	-	-	-	-
R165	-	-	X	-	-	-
R190	-	-	-	X	-	-
R220	-	-	-	X	-	-
R260	-	-	-	X	-	X
RT105	-	X	-	-	-	-
RT135	-	X	-	-	-	-
RT165	-	-	-	X	-	-
V210 - NEW	-	-	-	X	-	-
V230 - NEW	-	-	-	X	-	-
V270	-	-	-	-	X	-
V275 - NEW	-	-	-	-	X	-



# DIVERSE VOORZETSTUKKEN

Bereik



189 Mand materialen **NEW**

192 Pruning clipper (Compact machines) **NEW**



NEW

## MAND MATERIELEN



- 1.2m reach and 1000kg capacity.
- Transport and storage facilitated by its foldability.
- Efficient and inexpensive solution for the safe movement of materials in all types of application, environment and meteorology.
- Front opening facilitating pallet loading.



	MB 2000 / 1000
Capaciteit (lb)	2204.62
Gewicht (lb)	881.85
Totale hoogte (in)	4'
Totale lengte (in)	5' 4"
Breedte (in)	6' 9"
Diepte (in)	3' 8"
Machine-apparatuur	×

Machine compatibiliteit	
Referentienummer	52596600
MLT 630-115	X
MLT 630-115 V	X
MLT 630-115 V CP	X
MLT 635-130 PS+	X
MLT 635-140 V+	X
MLT 730-115 V	X
MLT 730-115 V CP	X
MLT 733-115	X
MLT 733-115 LSU	X
MLT 737-130 PS+	X
MLT 741-130 PS+	X
MLT 741-140 V+	X
MLT 841-145 PS+	X
MLT 850-145 V+	X
MLT 940-140 V+	X
MLT 1041-145 PS+L	X
MLT-X 625-75 H	X
MLT-X 737-130 PS+	X
MLT-X 741-140 V+	X
MLT-X 741 T LSU	X
MLT-X 841 - 145 PS+	X
MLT-X 850-145 V+	X
MLT-X 1041-145 PS+L	X
MT 625 e	X
MT 625 HA	X
MT 730 H	X
MT 733 Easy	X
MT 735 75D ST5	X
MT 930 H	X
MT 930 HA	X
MT 933 Easy	X
MT 935 75D ST5	X
MT 1033 easy	X
MT 1135 75 D	X
MT 1135 H 100D	X
MT 1135 easy ST5	X

## MB 2000 / 1000

Machine compatibiliteit	
MT 1135 H easy ST5	X
MT 1135 HA Easy ST5	X
MT 1135 ST5	X
MT 1335 75D ST5	X
MT 1335 100D ST5	X
MT 1335	X
MT 1335 easy ST5	X
MT 1335 H 75D ST5	X
MT 1335 H 100D ST5	X
MT 1335 H easy ST5	X
MT 1335 HA 75D ST5	X
MT 1335 HA 100D ST5	X
MT 1335 HA easy ST5	X
MT 1335 ST5	X
MT 1440 A ST5	X
MT 1440 easy ST5	X
MT 1440 HA ST5	X
MT 1440 ST5	X
MT 1840 A 100D ST5 S1	X
MT 1840 easy ST5	X
MT 1840 HA	X
MT 1840 ST5	X
MT-X 625 H	X
MT-X 733	X

VERPLICHTE UITRUSTING VAN MACHINES : ✕



NEW

## PRUNING CLIPPER (COMPACT MACHINES)



- 180° rotation on each side.
- Branches  $\varnothing$  max 15 cm.
- Windshield grid is recommended to work with this attachment.
- Electric predisposition on the boom head is also recommended.
- Works with a remote control to modify the hydraulic action.
- Great attachment for easy removal of trees, branches and brush from hard to reach areas, overrun pastures, fields and fence rows.





PRC 1500 / 180 R	
Gewicht (lb)	661.39
Totale hoogte (in)	2' 2"
Totale lengte (in)	5' 1"
Breedte (in)	3' 11"
Diameter maximum (in)	6"
Machine-apparatuur	

Machine compatibiliteit	
All-Tach®	52728899
4 point Carriage	52741065
Euro Carriage	52741064
GCT 3-14	X
GCT 3-14 +	X
ULM 412 H	X
ULM 412 H	X
ULM 415 H	X
ULM 415 H	X

**VERPLICHTE UITRUSTING VAN MACHINES :** 











MANITOU biedt standaard het voorzetherkenningssysteem aan op zijn nieuwe generatie roterende telescopische trucks MRT.

Het systeem maakt gebruik van de RFID-technologie voor radio-identificatie, die zeer veel wordt gebruikt in de industrie en de kleinhandel. Deze autonome techniek kan op afstand gegevens recupereren en registreren. De machine detecteert het voorzetstuk aan de kop van de giek, analyseert de gegevens en stelt rechtstreeks de overeenkomstige werkconfiguratie voor (werkbereik + bewegingssnelheid + veiligheid).

Deze technologie levert in real time de belastingsgrafiek, rekening houdend met de rotatiehoek van de toren en de positie van de stabilisatoren van de machine en in overeenstemming met de norm voor mobiele kranen.

## TABEL VAN SYMBOLEN

	Geen aanleg vereist
	Hydraulische leiding
	Hydraulische retour naar tank
	Elektrische voorbereiding
	Voorpositionering platform
	Voorpositionering bandenlichter, cilinderlichter
	Neem contact op met uw Manitou-dealer (verzoek om speciale oplossing vereist)
	Hangende lading : lees gebruikershandleiding
	Machine equipped with attachment recognition system



Landbouw



Bouw



Industrie

# OPMERKING

A series of 20 horizontal dashed lines for writing notes.

# OPMERKING

A series of 20 horizontal dashed lines for writing notes.

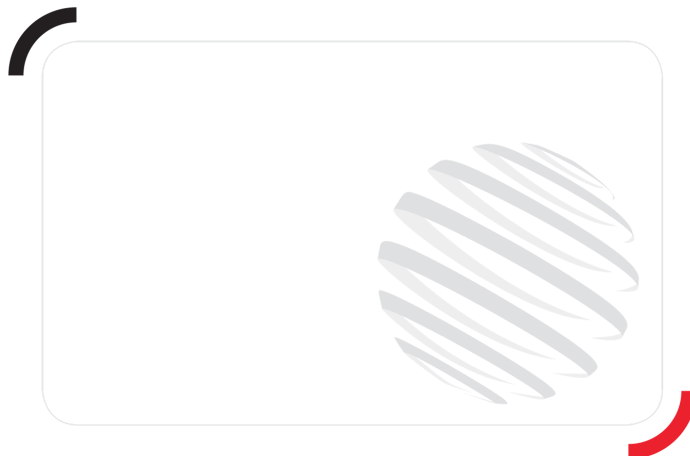

## **MANITOU** ATTACHMENTS

### Hoofdkantoor

B.P. 249 - 430 rue de l'Aubinière

44150 Ancenis Cedex - Frankrijk

Tel.: 00 33 (0)2 40 09 10 11 - Fax: 00 33 (0)2 40 09 10 97

[www.manitou.com](http://www.manitou.com)



Deze brochure beschrijft versies en con guratie-opties voor Manitou-producten die met verschillende apparatuur kunnen worden uitgerust. De uitrusting die in deze brochure wordt beschreven, kan standaard, optioneel of niet leverbaar zijn, afhankelijk van de uitvoering. Manitou behoudt zich het recht voor om de weergegeven en beschreven speci caties op elk moment en zonder kennisgeving vooraf te wijzigen. De fabrikant is niet aansprakelijk voor de gegeven speci caties. Neem voor meer informatie contact op met uw Manitou-dealer. Niet-contractueel document. De productbeschrijvingen kunnen afwijken van de werkelijke producten. De lijst met speci caties is niet allesomvattend. De logós en visuele identiteit van het bedrijf zijn eigendom van Manitou en mogen niet zonder toestemming worden gebruikt. Alle rechten voorbehouden. De foto's en diagrammen in deze brochure zijn uitsluitend bedoeld voor raadpleging en informatie.

MANITOU BF SA - Naamloze vennootschap met raad van bestuur - Aande- lenkapitaal: 39.668.399 euro - 857 802 508 RCS Nantes

20\_06\_2023\_19:02\_Accessoires\_attachments\_guide\_LANDBOUW\_NL